

AUGUST 1963

50c

# S9

*the citizens band journal*

381 CB TUBE SUBSTITUTIONS

284 QSL SWAPPERS LISTED

SHARPEN YOUR RECEIVER

CB SOLDERING TIPS

WHAT'S BEHIND RULE CHANGES?

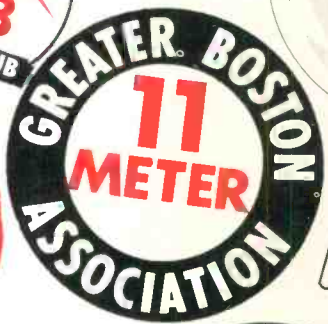
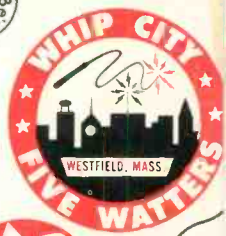

**NEW  
NEW  
NEW**

# Executive

A brand new compact control unit that permits the installation of transceivers in the automobile trunk or other out-of-the way space. Unit mounts under auto dashboard and gives you complete remote control of transceiver.

- **MOBILE OR BASE STATION OPERATION**
- **EASY INSTALLATION**
- **TURNS TRANSCEIVER ON AND OFF**
- **CHANNEL SWITCH**
- **ILLUMINATED DIAL**
- **DIMENSIONS: 2½" H x 7" W x 5" D**
- **RUGGED CONSTRUCTION**

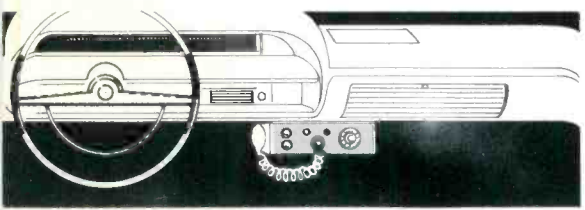
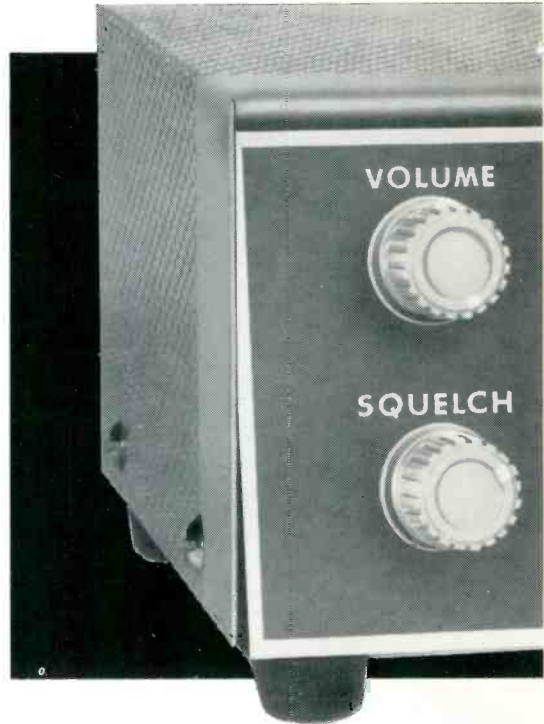

## TWO MODELS AVAILABLE

Model RM0-9 . . . a deluxe unit with 9 transmit and 9 receive channels. Complete with channel switch, but less crystals.....\$57.50

Model RM0-1 . . . for single channel operation. Does not contain channel switch. Complete less crystal .....\$42.50

## SPECIFICATIONS:

The International Executive Remote Console is designed as a companion accessory for remote operation of the Model 50 and Model 100 transceivers. The console contains the receiver/converter stages (uses the printed circuit board from your present Executive) plus a new transmitter oscillator. The attractive console blends with and compliments your auto instrument panel. Console panel includes illuminated dial, On-Off switch, volume control, squelch, transmit and receive indicator lights, push-to-talk microphone socket.

Citizens Band licensees with International equipped stations know the unquestioned superiority and advantages of Executive transceivers and their system engineered accessories.

SEE THE EXECUTIVE REMOTE CONSOLE AT YOUR INTERNATIONAL DEALER . . . TODAY!

**INTERNATIONAL**  
CRYSTAL MANUFACTURING CO., INC.

18 NORTH LEE • OKLAHOMA CITY, OKLA.

The logo for International Crystal Manufacturing Co., Inc. features a stylized globe with latitude and longitude lines. The word 'INTERNATIONAL' is written in large, bold, sans-serif capital letters across the top of the globe. Below the globe, the words 'CRYSTAL MANUFACTURING CO., INC.' are written in a smaller, bold, sans-serif font. At the bottom of the logo, the address '18 NORTH LEE • OKLAHOMA CITY, OKLA.' is printed in a standard sans-serif font.

# REMOTE CONSOLE

for International Model 50 and Model 100 Citizens Band transceivers



## INTERNATIONAL "MATCHED" ACCESSORIES FOR THE EXECUTIVE TRANSCEIVERS



### EXTERNAL SPEAKER and S/METER

Combination speaker and S/meter for the Model 100 Executive. Utilizes a high impedance vacuum tube volt meter circuit. Connects to socket on rear of transceiver. S/meter reads in three ranges. Brown cabinet, brown and silver panel matches transceiver.

Complete with interconnecting cable .....\$49.50



### EXECUTIVE SPEECH CLIPPER/FILTER AMPLIFIER

A microphone amplifier designed to increase average modulation . . . limits modulation peaks . . . filters audio frequencies above 2500 cycles. Permits arms length microphone operation. Power requirements: 12 vac or 12 vdc.

Complete with interconnecting cable .....\$36.50

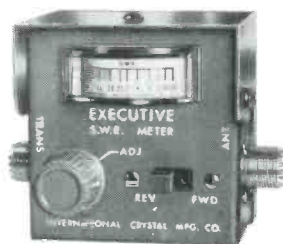

### EXECUTIVE S. W. R. METER

Checks efficiency of mobile or base station antenna system by measuring forward and reflected power or standing wave ratio. May be installed permanently in transmission line. Size: 2 $\frac{5}{8}$ " x 3 $\frac{1}{8}$ " x 1 $\frac{7}{8}$ ". Maximum power: 5 watts. Matches 50 ohm line.

Complete with instructions .....\$19.50





the citizens band journal

Vol. 3, No. 2

August, 1963

S. R. COWAN, PUBLISHER

300 West 43rd Street New York 36, N. Y.

### FEATURES

Telegram & Reply .....	Tom Kneitel, KBG4303	7
Further comment on ACBA antics.		
Your Club Emblem .....	Jim Gibson, 2W7610	9
How to get one free, etc., etc.		
Let's Change The Rules .....	Federal Communications Commission	12
The exclusive "inside story" on how it's done.		
Sharpen Your Receiver .....	Jim Kyle, KEG3382	15
Cheap & dirty modification makes for hot selectivity.		
S9 CB Tube Substitution Directory .....	Stephen Dedalus, 12W5415	18
381 exact replacements for most popular CB tubes.		
CB Soldering Tips .....	John A. Comstock	21
Bet you never thought of these ideas.		
Mess o' Schmidts .....	Jack Schmidt	22
Well known "pro" does his stuff for S9'ers.		
Part 15 Callbook .....		33
Our regular installment.		
Card Swappers Like Maaaaad! .....		36
In fact, almost 300 of them this month!		
CB Ambulance Service .....	Lee Aurick, 2W2870	38
CB to the rescue, again!		
Curing Hi-Fi Interference .....	Don Stoner, 11W1507	40
At long last, here's how to get rid of it!		
All About CB Signal Propagation .....	Ed Noll, KCC2618	46
Secrets behind CB "skip."		
Latest FCC CB Actions .....	Edwin Frederick, 2W4580	49
20 CB'ers feel FCC's teeth.		

### DEPARTMENTS

Reader Mail .....	4
KBG4303 Rides Again/Tom Kneitel, KBG4303 .....	7
Part 15 Korner/Dean Detton, N-17 .....	34
On The Counters .....	25
Antennas/Ed Noll, KCC2618 .....	46
Card Swappers Unlimited .....	36
CB Answerman/Len Buckwalter, KBA4480 .....	42
CB Casebook/Lee Aurick, 2W2870 .....	38
CB Chit Chat /John Krejc, 2W4586 .....	42
Washington Outlook/Ed Frederick, 2W4580 .....	49
Electronics 'n Stuff/Don Stoner, 11W1507 .....	42

### STAFF

editor Tom Kneitel, KBG4303

- contributing editor Lee Aurick, 2W2870
- contributing editor Ed Noll, KCC2618
- contributing editor Edwin Frederick, 2W4580
- contributing editor Paul Arnovitz, XMS2127
- contributing editor John Krejc, 2W4586
- editorial asst. Lilia Neira
- advertising representative Dick Cowan
- advertising representative Jack Schneider, 2W5669
- circulation manager Hal Weisner, KBG4528
- production manager Cary L. Cowan, KBG4036
- edit. production Sol Nussbaum, KBG4903
- publication consultant David Saltman

S9 (title registered U.S. Post Office) is published monthly by Cowan Publishing Corp. Executive, editorial and advertising offices at 300 West 43rd Street, New York 36, N. Y. Telephone JU 2-4460.

Subscription Rates: One year \$5.00, two years \$9.00, three years \$13.00 in United States and Possessions, APO, FPO, and Canada.

Printed in U.S.A. Entire contents copyright 1963 by Cowan Publishing Corp. S9 does not assume responsibility for unsolicited manuscripts. We regard all material sent to us in CB club publications as being intended for publication in S9 as a public relations gesture of the club. We cannot pay for the use of this public relations material, although we do pay for editorial material which is specifically written for us and accepted for publication.

Controlled Circulation Postage Paid at New York, N. Y.

POSTMASTER: SEND FORM 3579 TO: S9, 300 WEST 43RD STREET, NEW YORK 36, N. Y.

# FEATURE FOR FEATURE — DOLLAR FOR DOLLAR YOUR BEST BUY IN CB RADIO

## THE NEW RCA MARK VIII

27-Mc CITIZENS BAND 2-WAY RADIOPHONE

UP TO 9 FIXED, CRYSTAL-CONTROLLED TRANSMIT-AND-RECEIVE CHANNELS. PLUS ALL-CHANNEL TUNABLE RECEIVER.

CONVENIENT ACCESS TO CRYSTALS FOR QUICK CHANG NG.

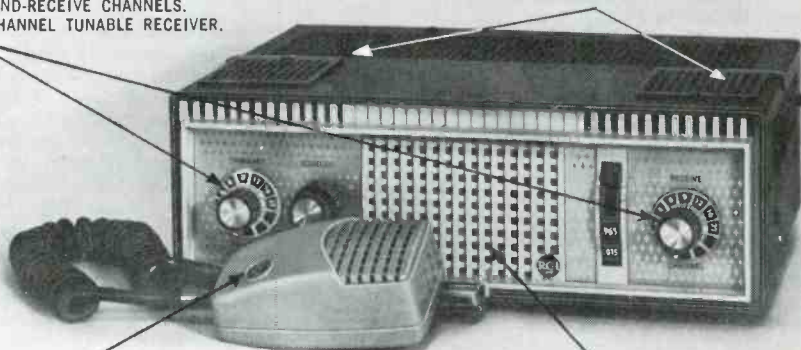

PUSH-TO-TALK CERAMIC MICROPHONE with coiled cord.

EXCELLENT VOICE REPRODUCTION—high intelligibility.

EXCELLENT TRANSMITTER MODULATION CHARACTERISTICS

IMPROVED AUTOMATIC NOISE LIMITER reduces effects of ignition and similar interference.

COMPACT AND LIGHTWEIGHT 3½" high, 9 pounds. Fits easily under any auto dashboard.



Continuously tunable receiver picks up any of the 23 C-B channels. Tunes either by channel number or frequency.



Illuminated working channel. Pilot lamps behind the fixed-channel dials show the channels being worked.



Separate mobile power supply. (Optional) 6- or 12-volt, for car or boat. All units contain AC power supply.



Channel-marker kit. Select channels best for your area, then mark them with the self-adhering labels included.

ONLY **\$14950\***  
\*OPTIONAL LIST PRICE

Get all the Facts Before You Buy.  
Mail Coupon Today. Paste on 4¢ Post-Card.

RCA ELECTRONIC COMPONENTS AND DEVICES  
Commercial Engineering Dept. H-132-R  
415 South Fifth Street, Harrison, N. J.

Please send more information on the RCA Mark VIII C-B Radiophone

Name \_\_\_\_\_

Address \_\_\_\_\_

City \_\_\_\_\_ Zone \_\_\_\_\_ State \_\_\_\_\_



The Most Trusted Name  
in Electronics

Write to our advertisers for special product news

August 1963 • 59 • 3

# READER MAIL

## EDITORIAL POLICY

Dear Tom:

First I want to say how much I appreciate your wonderful CB magazine and know you must be very proud of it. I have enjoyed every copy but am not very happy about the way the editorials are written about the FCC and their Commissioners. Don't you think it is time to give the owners of CB rigs a little support and not try to scare them to death about what the FCC is going to do, etc., such as giving them the axe?

Thanks again for your wonderful CB magazine.

Ernest L. Walker, ex-15W1670  
Espanola, N. M.

*Mr. Walker, we appreciate your comments regarding S9 but must disagree with you on your suggestion that we suppress information on Show Cause notices and license revocations. It happens to be a fact that skip workers lose their licenses—as you yourself did. I'm certain that the example given by your own unfortunate experiences when tangling with the FCC is of benefit to many CB'ers. We hope that in your position as Executive Secretary of the American Citizens Band Assn. (ACBA) you will change your position and show CB'ers that there really is a "correct" way of using CB.*

## CALL AREA MAP?

Dear Sirs:

Where can I get a map of the U.S. showing all of the CB call areas?

William Hervey  
Clearwater, Fla.

*You came to just the right place, Bill. S9 has the only map which gives all prefixes ever issued to each CB call area. It even has next year's prefixes. Get them, in flashy red-on-white, suitable for decorating the CB shack, for only 25¢ each. Order from "Wall Certificate Dept.," S9 Magazine, 300 West 43 St., New York, N. Y. No stamps please.*

## "UNTIMELY HOTFOOT" COMMENT

Editor:

Thanks for your June editorial entitled "Untimely Hotfoot."

We are in serious need of a truly national CB club, but not one packed only with members of the hobby element of CB radio. Your "Washington Outlook" is in my opinion a good enforcement tool in bringing to light the CB'ers who run into Show Cause notices, etc. If we can't reason with the CB "talkers" perhaps we can scare them into shutting up!

Keep up the "sound judgment" approach to CB problems. We need your sobering influence to calm the storms stirred up by the "March on Washington" group.

(name withheld on request)  
South Carolina

Tommy,

After reading your editorial in June I want to thank you for the true interest you have in CB'ers

and the proper use of the service.

It seems that some clubs and another publication are more interested in Class D as a hobby than what it was set up for. Sure, I like to chat with a few of my friends when the channels are open, but I stay off the air when the skip is in because some of the stuff heard here would make anyone sick, not only the FCC.

You have the VERY BEST coverage in the CB publication field.

Ralph Sorensen, 16Q1960  
Bay City, Wis.

Tom:

Your June issue, especially the editorial, was really "WOW!" You absolutely outdid yourself. If you never write another line you can rest on your laurels from "Untimely Hotfoot." I could have closed the magazine after reading this, never received another issue of my subscription, and I would have had my money's worth 10 times over. Thanks.

Karl Lyon, 2A4671  
Garfield, N. J.

*These are but a sampling of the swamp of letters which hit us as soon as the June issue went to CBland. See "KBG4303 Rides Again" on page 7 of this issue for commentary on the gigantic hornet's nest we stirred up with the June editorial about "hate-the-FCC-clubs."*

## GOOD RESULTS

Editor:

I have recently completed constructing the "Vertical J" antenna described in your June "antenna Issue." Using the components described, the total construction time was less than two hours. No problems were encountered in erecting the antenna, however the mounting arrangement could probably be made a little simpler.

Local reception reports have been very gratifying and even distant ground contacts show a marked improvement over several previous antenna systems used. The antenna has survived a couple of strong wind storms.

I have found that it is an expensive antenna to construct and *dollar for dollar* it is perhaps the best antenna I have ever used.

Robert C. Bishop, Design Engineer  
Crater Lake Antennas  
Box 333, Old Chelsea Station  
New York 11, N. Y.

## CALLING CHANNELS

Gentlemen,

During my travels across the country I find that there is no coordination to use the 23 channels to advantage. As a result I find various calling channels when traveling in different cities, usually being 7, 9 and 11. Why not establish one nationwide channel for calling?

In my travels I find that usually all traffic is conducted on 5 or 6 channels with all others idle.

*Continued on page 52*

one way or the other,  
you gain the most with  
antenna specialists'

**NEW**  
**"Match-Maker"**  
MR 77 (27 Mc)  
**Vertical/Horizontal Beam Antenna**

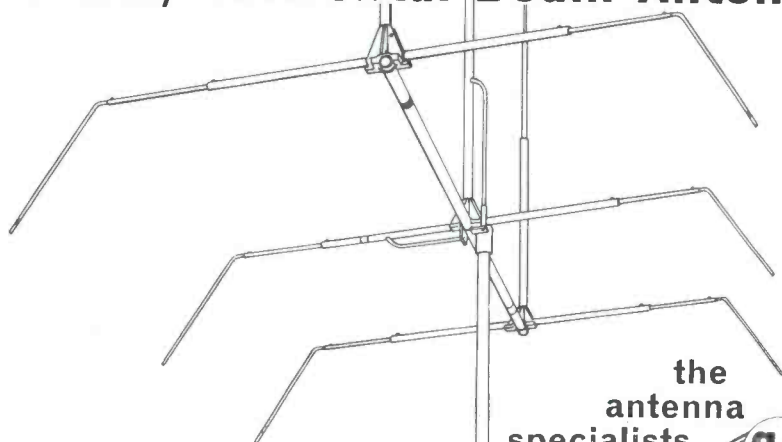

Now you can instantly match up your base antenna to work mobile and vertical bases or horizontal base beams by simply switching from vertical to horizontal polarization through separate coax feeders. The dual-direction versatility of the "Match-Maker" will give you a powerful 7 db. vertical forward gain. Switch to the horizontal beam and you get a 6 db. forward gain. Either way, you get a 15 db. front to back ratio.

Everything about the "Match-Maker" is rugged. Sturdy, heat-treated aluminum boom and elements plus oversize clamps to hold elements firmly in place give it the structural strength to withstand 100 mph winds. Only 12½' high with a boom length of 10', it weighs an easy-to-handle 24 lbs. If you're interested in VSWR, it's 1.5:1 or less, either horizontally or vertically. 50 ohms, gamma matched. All components are color-coded for simple, fast, accurate assembly.

the  
antenna  
specialists  
co.



Antenna Division,

12435 Euclid Ave., Cleveland 6, Ohio

Manufacturers of Antenna Specialists brand base and mobile antennas for amateur, professional and CB. Custom design broadcast and professional installations.



*Holy smokes!  
we almost forgot  
the ZEUS!*

The portable power generator with only one moving part. Alternator principle. 1000, 1250, 3000 watt models. Write for complete information.

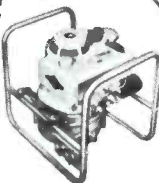



# HEATHKIT CITIZEN'S BAND

world's biggest line  
of top quality  
2-way radio values



#### MARINE CB

Styled to match Heathkit Marine equipment • 5 transmit-receive channels • All channel tuning • RF stage for extra sensitivity • Crystal filter for extra selectivity • Efficient transmitter for extra range • 3-way power supply • Kit MW-33, \$89.95



#### DELUXE MASTER STATION

5 transmit-receive channels • All-channel tuning • 4-tone selective calling • Tuning meter • Squelch • Noise limiter • 3-way power supply • Kit GW-42, \$119.95

#### ACCESSORIES

Heathkit offers a complete line of CB accessories including selective-call kits, mobile and fixed station antennas, microphones, and extra crystals.



#### SINGLE CHANNEL

One transmit-receive channel • Sensitive superhet. receiver • Squelch • Noise Limiter • AC power supply plus accessory DC supply • Kit GW-12A, \$39.95



**GW-52-1 WATT**  
10-transistor, 2-diode circuit; 1/2 uv sensitivity; built-in charger; \$20 rechargeable battery included. Pair \$139.95; Each \$74.95

#### Walkie Talkies

**GW-30-100 MILLIWATTS**  
4-transistor circuit; 4 uv sensitivity; 9-v. battery lasts to 75 hours. Pair \$35; Each \$19.95



**GW-21-100 MILLIWATTS**  
9-transistor, 2-diode circuit; 1 uv sensitivity; 9-v. battery lasts to 75 hours. Pair \$84.95; Each \$44.95

Heathkit, pioneer name in citizen's band radio . . . the name found wherever fast-moving, dependable 2-way radio communications are functioning . . . the name associated with quality at great savings. Whether you use citizen's band radio for your work or recreation, there is a Heathkit CB model to fit your purpose and budget. Five different 5-watt basic transceiver models are available with various power supply options. Three different walkie-talkie units are ready to keep you "in touch" . . . each in a different power and price class. And all Heathkit CB equipment is available as do-it-yourself kits or factory-assembled and tested . . . either way, you save more, get more for your money with a Heathkit. See the Heathkit Catalog for full details on the very model you need to put you "on the air."

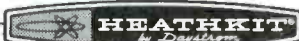

HEATH COMPANY / Benton Harbor 43, Michigan

Please send my free 1963 Heathkit catalog

Name \_\_\_\_\_

Street \_\_\_\_\_

City \_\_\_\_\_ Zone \_\_\_\_\_ State \_\_\_\_\_

Prices and specifications subject to change without notice. Dealer & Export prices slightly higher.



**FREE 1963 HEATHKIT CATALOG**  
Over 250 money saving, do-it-yourself kits for stereo/hifi, citizen's band, amateur radio, marine, test & lab., educational, electronic organs, television, and more. Save up to 50% on your electronic equipment needs, with Heathkit. Send for your free Heathkit catalog today!



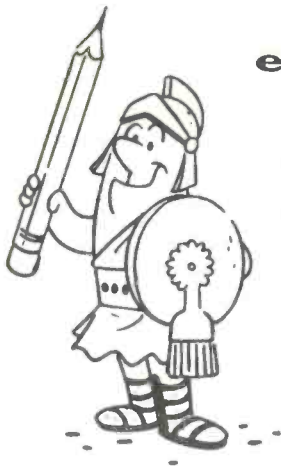

editorial

# KBG4303 rides again!

by TOM KNEITEL  
EDITOR, S9

## TELEGRAM AND REPLY

The following telegram was received on June 2nd:

TOM KNEITEL  
S9 MAGAZINE, NEW YORK, N. Y.  
HAVE READ WITH INTEREST YOUR UNTIMELY HOTFOOT JUNE S9 MAGAZINE IT APPEARS THAT YOU DO NOT KNOW ENOUGH ABOUT ACBA TO BE AN OBJECTIVE CRITIC, YOU ARE NOT CAPABLE OF BEING AN UNBIASED REPORTER. STRONGLY SUGGEST YOU STUDY FACTS BEFORE WRITING IN FUTURE. I AM NOT AN AMBASSADOR TO WASHINGTON. I HAVE NO INTENTION OF BEING ONE. THE ACBA IS NOT ANTI-FCC; CONTRARY, PAUL THACKER, PRESIDENT OF ACBA SPENT 3 HOURS WITH CHAIRMAN HENRY MAY 16 AND AN HOUR WITH IVAN LOUCKS ON SAME DATE. THE CHAIRMAN ASKED MR. THACKER TO SUBMIT WHAT THE ACBA FEELS WOULD BE GOOD SOLUTION FOR HOBBY CHANNELS. THIS HAS BEEN DONE. THE ACBA FEELS YOU ARE DELIBERATELY MISLEADING YOUR READERS BECAUSE OF YOUR FEUD WITH CB HORIZONS. THEREFORE I HEREBY CHALLENGE YOU TO AN OPEN DEBATE BEFORE THE NATIONAL CONVENTION IN KINGSPORT, TENNESSEE, SATURDAY, JUNE 29, ON THE MERITS OF THE ACBA. WE ARE MAKING A MAILING TO ALL CB CLUBS IN COUNTRY THIS DATE ADVISING THEM OF THIS CHALLENGE. IF YOU HAVE THE COURAGE OF YOUR CONVICTIONS, YOU WILL BE THERE. IF YOU DO NOT, YOUR ABSENCE WILL TELL THE STORY.  
ERNEST L. WALKER, EXECUTIVE SECRETARY  
AMERICAN CITIZENS BAND ASSOCIATION, INC.

It was an interesting reaction to the June S9 editorial, "Untimely Hotfoot." We must confess that this particular editorial was laced with some "bait" to elicit a response from the ACBA—exactly the one which was sent in this telegram. The "bait" was the fact that nowhere in the editorial was the ACBA described by name; we merely enumerated a number of facts about an otherwise unidentified "anti-FCC club." This is the old bit of identifying the "crime" and letting the "guilty" party become so enraged that he

identifies himself. So there is no question about the fact that the ACBA identifies itself with the facts presented, since no other club contacted us similarly.

Now to get to specifics. Perhaps in the ACBA's zeal in condemning the S9 editorial they forgot that one of the basic American freedoms is a "free press." As part of this free press, S9 is accountable to its readers to freely, honestly and capably express its views and opinions on the passing CB scene. S9 is the *only* nationally distributed CB publication which does not have to consider the various aspects (both commercial and otherwise) of an affiliated "national club" when formulating its editorial opinions. We have therefore full and complete latitude in "calling a spade a spade." We can sympathize with the ACBA's anger when the spade we called happened to be them, however S9 editorials are nevertheless the fruits of a free press. It is understandable that in the ACBA's overlooking this aspect of the publishing business, with which they are obviously unfamiliar, they might have made some erroneous assumptions.

The image breaking with which the editorial in question was written, together with the listing of what we at S9 feel are some of the poor points of ACBA probably seems random and extremely arbitrary to the ACBA. But to bash in all the ideals, impertinences, aspirations, promises, myths, attitudes, tactics, and philosophies of ACBA which we (and many other CB'ers who have written us) find deplorable would fill volumes. Since, however, the opinion which we intended to convey in "Untimely Hotfoot" was that the entire galaxy of ACBA ideas was wrongly conceived and is being idiotically pursued, our method therefore was like a poll—a cross sectioning. Our literary technique was to invade the readers' feelings (his values) as much as his reason by giving specific facts

*Continued on page 52*



## Think smallest.

Planning to buy a mobile CB rig? Think smallest. Buy the smallest 23-channel mobile CB transceiver on the market . . . the Browning Drake M-523. It's so compact it fits perfectly under the dash, and you can still ride three in front comfortably. Perfect for sports cars. The Browning Drake M-523 and M-506 (six-channel version) are 8" x 9" x 3" small. What's more, we use only tubes in the circuits for utmost reliability — and you don't have to be an electronics engineer to make repairs or change a tube. Right now we have over 100 franchised Browning Service Centers across the nation where you can see, try (if you have a license) and buy the Drake or any other Browning CB equipment. We will gladly tell you where the nearest one is in your area. Before you buy just any mobile CB equipment, THINK SMALLEST . . . BUY BROWNING. Then start enjoying CB as it should be.

Mail Coupon Today

Browning Laboratories, Inc., Dept. S9  
100 Union Ave., Laconia, N.H.

WITHOUT OBLIGATION, PLEASE SEND:

- Name of nearest Service Center.
- 16-page color CB catalog.

NAME \_\_\_\_\_

ADDRESS \_\_\_\_\_

CITY \_\_\_\_\_ ZONE \_\_\_\_\_ STATE \_\_\_\_\_

CALL LETTERS \_\_\_\_\_



LABORATORIES, INC.  
LACONIA, NEW HAMPSHIRE

# YOUR CB CLUB EMBLEM

IT'S POSSIBLE TO HAVE ONE DESIGNED

PROFESSIONALLY—AND FREE!

by JIM GIBSON, 2W7610

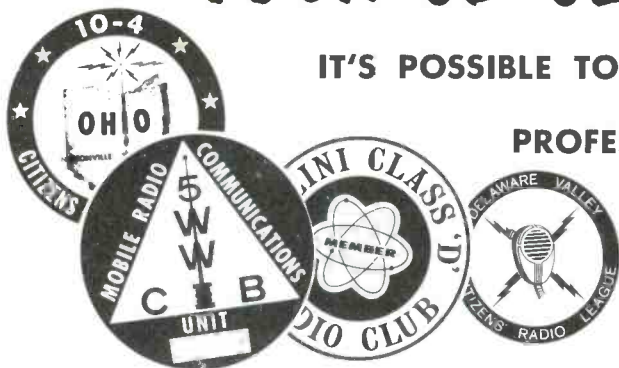

The lifeblood of any CB association's publicity and public relations program is a permanent and continuing identification and public image. One of the best methods of accomplishing this is by transforming each member's windshield into a billboard extension of the club's overall public relations program. *Billboard?* Right! your colorful club emblem placed in a conspicuous spot on each member's mobile unit identifies the operator as an active participant in an efficient CB organization. Your club emblem will attract new members and also provide a ready means of identification.

The emblem you now have can be easily, and economically, transferred into a multi-colored decal and distributed to the members

You don't have a club emblem yet? You don't have any ideas for one? Worry not! S9 has news for you on how your club can have a professionally designed emblem—and have it transferred into a snappy decal for billboard use on members' windshields. This information has never before been presented for CB'ers.



Fig. 1

at cost or with some profit which is always welcome in a CB club "kitty."



Fig. 2

## DIFFERENT TYPES

There are two ways for making CB club emblem decals. The first, and most inexpensive method, is with the use of a pre-printed basic design decal which bears no club name or other information. Figure 1 shows both the pre-printed blank CB decal and also two completed versions as now in use by CB clubs. This particular style comes in orange, metallic gold, and white and the club has its information overprinted in black. Prices on this particular style average 44 cents each in lots of 50, and 30 cents each in lots of 100. Other similar styles are also available with prices in the same range. These were supplied



to S9 by Chuck Baer Enterprises, 6429-S N. Glenwood Ave., Chicago 26, Ill.

### CHEAPER YET

Still even more inexpensive is the type shown in Figure 2, it's bigger than the ones in Figure 1 (about 5½" round) but is available only in a white background with a single dark color (red, blue, green, maroon, black and a few others) overprinted; or, it is available with white lettering on a single colored dark background. Prices are 25 cents each in lots of 100. These are also from Chuck Baer Enterprises.

### SUPER DELUXE VERSIONS

If your club really wants something *very* special in the way of a distinctive club emblem and decal then there is nothing like a customized one designed exclusively for your club. This month's S9 cover shows a number of these emblems and several others are shown in Figure 3.



Fig. 3

Although you will probably have to place a minimum order for 100 decals, you have a choice of any size, shape, color combination, and design of your desire (and pocketbook). All you do is send a copy of your emblem to the manufacturer and sit tight for 3 or 4 weeks and zingo—a CB club decal. The normal process involves sending you a proof of the decal before going to press just to make certain that there aren't any last minute changes-of-heart on your part.

OK, say you don't have an emblem—just an idea for one. You might write the manufacturer and say, "We want a map of the state with an antenna tower and lightning bolts in the northeast corner. We want it in red, white, and blue in a circular design about 3 inches around." In a week or two you'll receive, at no charge, an artists rendering of your idea. If you like it, fine; if you don't like it, they'll try again.

Or, suppose you haven't any idea at all of what you want. The manufacturer can probably supply you with a batch of samples which were used by other CB clubs or he might even make up a new design for your club. Just a reminder though, these designs cost the decal manufacturer quite a bit of time and money and a club requesting same should be genuinely interested in getting decals rather than just getting "something for nothing."

The most popular size decal for CB clubs has been a round style, 3 to 3¼ inches in diameter. This equals about 10 square inches and the following "single decal" prices are typical for this size:

	NUMBER OF DECALS ORDERED		
	100	200	300
2 colors	34½¢	19¢	16¢
3 colors	43½¢	24½¢	21¢
4 colors	53¢	30¢	25¢

White and "clear transparent" are both counted as colors.

### WANT TO FIND OUT MORE?

The "yellow pages" telephone usually lists decal manufacturers. There are two companies, however, which have done quite a bit of very good work for CB clubs, Call-D-Call of Los Angeles, Calif., and Ernest A. Vernon & Son of Blue Island, Ill.

Both of these manufacturers sell their decals through dealers and Call-D-Cal, for instance, has about 75 dealers set up for this purpose. If you are interested in further information on a club emblem we suggest that you contact some of these dealers. Notable among them are Errol Engraving Service, 36 Hampden Street, Westfield, Mass. (ask for their entire catalogue of CB "goodies" in addition to the decal information, it's worth having), Dick Stauffer, 1996-S N. M-18, Gladwin, Mich. (If you enclose 25¢ with your request he'll send some nifty CB-QSL samples which he prints at reasonable prices), and Chuck Baer Enterprises, whose address we mentioned earlier (they have a swell catalogue of CB jewelry and other personal accessories which you might like to keep around the shack).

So put that dusty old windshield to use! Get that CB club emblem up there and let 'em know you belong!

**S9**

# BE CHOOSY!

*There's a Hammarlund CB unit*

# JUST RIGHT FOR YOU

Fifty years of communications experience backs your choice. From the rugged, hard working commercial/industrial CB-Six to the CB enthusiast's favorite transceiver—the versatile CB-23. Add to this the HQ-105 TRS, designed for the CBER with a Ham ticket and/or short wave listening in mind and you can choose the Quality Hammarlund unit best suited for your needs.

**HQ-105 TRS**



With one unit you get both Ham and CB coverage—and can listen to short wave stations all over the world. This is a quality communications receiver with a built-in 5 watt transmitter—which can easily be retuned for 10 meter use when you get your Ham ticket.

**\$22450**

**CB-23**



Just add an antenna and you're ready to GO! 23 channel Transmit and Receive—crystal controlled. One price buys all—crystals, squelch, noise limiter, S-Meter, plus cables for 12v. DC mobile and 117v. AC base station operation.

**\$24950**

**CB-SIX**



**NEW**

Heavy duty six-channel unit built for rugged commercial/industrial use.  $\pm$  3KC vernier tuning control peaks in off-channel signals for maximum reception. Built-in power supply furnishes 12v. DC mobile or 117v. AC for base station use.

**\$17950**

Includes two crystals



**HAMMARLUND** Manufacturing Company

A Giannini Scientific Company • 53 West 23rd Street, New York 10, N. Y.

Please send technical literature on following checked CB units.

- HQ-105 TRS      NAME .....
- CB-23              ADDRESS .....
- CB-Six             CITY & STATE .....

# LET'S CHANGE THE RULES!

THE FCC EXPLAINS FOR S9'ers HOW THEY DO IT

by FEDERAL COMMUNICATIONS COMMISSION

*There seems to be considerable misunderstanding among CB'ers concerning the mechanics of rule-making at the FCC. This is borne out by the amazing number of improperly submitted comments and general confusion which was commonplace as a result of the recent FCC notice of proposed rule-making concerning Part 19. To clear up this confusion, we asked the Commission to explain for S9 readers, in clear and simple language, the various aspects of getting a rule change proposed and passed. Here is their reply.*

—KBG4303

As with nearly all governmental agencies, the rule-making procedures of the Commission are governed by the Administrative Procedure Act, and may be originated either on the Commission's own motion or as a result of a petition requesting such rule making which the Commission finds to have actual or possible merit. The first formal step in such rule-making is the issuance of a Notice of Proposed Rule Making or a Notice of Inquiry.

In the case of a Notice of Proposed Rule Making, such notice must receive a Docket number, must be published in the Federal Register, must include either the terms or substance of the proposed rule or a description of the subjects and issues involved, must include a statement of the time, place, and nature of any public rule making proceedings, must reference the authority under which the rule is proposed, and must afford interested persons an opportunity to participate in the rule making through submission of written data, views, or argu-

ments. The Commission customarily allows a period of thirty (30) days after publication in the Federal Register for the receipt of comments, but this period is not fixed, and may be as much greater than thirty days as appears appropriate in view of the relative complexity of the rule making involved.

Subpart C (Sections 1.202 through 1.219) of Part I of the Commission's rules, which sets forth in detail its rules governing rule making practice and procedure, and to which reference should be made for the precise requirements of the Commission, specifies among other things that an original and 14 copies of all comments, replies, pleadings, briefs, and other documents filed in a rule making proceeding shall be furnished the Commission. It might be pointed out here that this requirement, which governs all of its rule making proceedings, is designed to provide each of the seven Commissioners and each Commission staff office involved with individual copies of such submissions so that all those involved may be fully informed and the proceeding not be unnecessarily delayed.

Upon the conclusion of the specified comment period and any extension thereof granted by the Commission, and the additional period provided for reply (or rebuttal) filings, the Commission and its staff considers all relevant comments and material of record received in the proceeding, together with any other information available to it, and, if it is satisfied that no useful purpose would be served by further public proceedings, the Commission will issue its decision incorporating its findings and a



brief statement of the reasons therefor. The effective date of the rules or rule amendments adopted by the Commission in its decision is such a proceeding is normally at least thirty (30) days after the publication of the Order of the Commission in the Federal Register.

Inquiries addressed to the individual commissioners or staff members as to the possible outcome of such proceedings must, of necessity, await a decision by the full Commission. As soon as the Commission has reached its decision and the new rules or rule amendments involved have been drafted, compiled and approved, the Order promulgating such rules will be published in the Federal Register and a copy will be mailed to each party of record in the proceeding.

Further details of the legal and official provisions governing rule making may be obtained by reference to Section 4 of the Administrative Procedure Act, to Section 303 of the Communications Act of 1934, as amended, and to Sections 1.202 through 1.219 of Part 1, Practice and Procedure, of the Commission's Rules.

**S9**

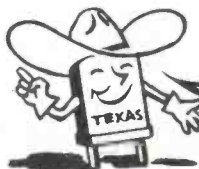
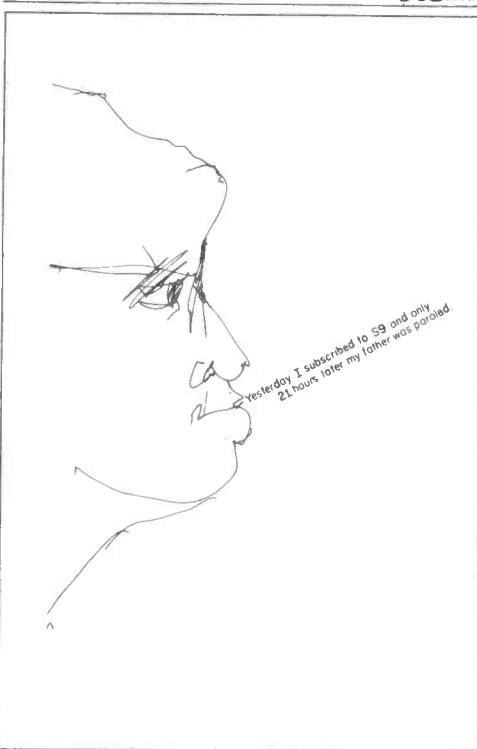

Send for NEW  
FREE CATALOG #961  
with oscillator  
circuits

## Citizen Band Class "D" Crystals

**CITIZEN BAND CLASS "D" CRYSTALS**  
3rd overtone — .005% tolerance — to meet all FCC requirements. Hermetically sealed HC6/U holders. 1/2" pin spacing. .050 pins. (Add 15c per crystal for .093 pins).

**\$2.95**  
EACH

All 22 megacycle frequencies in stock: 26.965, 26.975, 26.985, 27.005, 27.015, 27.025, 27.035, 27.055, 27.065, 27.075, 27.085, 27.105, 27.115, 27.125, 27.135, 27.155, 27.165, 27.175, 27.185, 27.205, 27.215, 27.225.  
Matched crystal sets for ALL CB units (Specify equipment make and model numbers) **\$5.90 per set**

### CRYSTALS IN HC6/U HOLDERS

<b>SEALED OVERTONE</b>	.486 pin spacing — .050 diameter — .005% tolerance	
	15 to 30 MC	<b>\$3.85 ea.</b>
	30 to 45 MC	<b>\$4.10 ea.</b>
	45 to 60 MC	<b>\$4.50 ea.</b>
<b>FUNDAMENTAL FREQ. SEALED</b>	From 1400 KC to 2000 KC	<b>\$5.00 ea.</b>
	.005% tolerance	
	From 2000 KC to 10,000 KC, any frequency, .005% tolerance	<b>\$3.50 ea.</b>
<b>RADIO CONTROL</b>	Specify frequency. .05 pins spaced 1/2" (Add 15c for .093 pins).	<b>\$2.95 ea.</b>



## QUARTZ CRYSTALS FOR EVERY SERVICE

All crystals made from Grade "A" imported quartz—ground and etched to exact frequencies. Unconditionally guaranteed! Supplied in:

<b>FT-243 holders</b>	<b>MC-7 holders</b>
Pin spacing 1/2"	Pin spacing 3/4"
Pin diameter .093	Pin diameter .125
<b>CRIA/AR holders</b>	<b>FT-171 holders</b>
Pin spacing 1/2"	Pin spacing 3/4"
Pin diameter .125	Banana pins

<b>MADE TO ORDER CRYSTALS</b>	Specify holder wanted
1001 KC to 1600 KC: .005% tolerance	<b>\$4.50 ea.</b>
1601 KC to 2500 KC: .005% tolerance	<b>\$2.75 ea.</b>
2501 KC to 9000 KC: .005% tolerance	<b>\$2.50 ea.</b>
9001 KC to 11,000 KC: .005% tolerance	<b>\$3.00 ea.</b>

### Amateur, Novice, Technician Band Crystals

.01% Tolerance . . . **\$1.50 ea.** — 80 meters (3701-3749 KC)  
40 meters (7152-7198 KC), 15 meters (7034-7082 KC), 6 meters (8335-8650 KC) within 1 KC  
FT-241 Lattice Crystals in all frequencies from 370 KC to 540 KC (oll except 455 KC and 500 KC) **50c ea.**  
Pin spacing 1/2" Pin diameter .093  
Matched pairs — 15 cycles **\$2.50 per pair**  
200 KC Crystals, **\$2.00 ea.**; 455 KC Crystals, **\$1.25 ea.**; 500 KC Crystals, **\$1.25 ea.**; 100 KC Frequency Standard Crystals in HC6/U holders **\$4.50 ea.**; Socket for FT-243 Crystal **15c ea.**; Dual Socket for FT-243 Crystals, **15c ea.**; Sockets for MC-7 and FT-171 Crystals **25c ea.**; Ceramic Socket for HC6/U Crystals **20c ea.**

**ENGINEERING SAMPLES** and small quantities for prototypes now made at either Chicago or Fort Myers plants with 24 hour service. IN CHICAGO, PHONE GLadstone 3-3555

**IF YOUR PARTS DEALER DOESN'T STOCK** Texas Crystals, order direct and send us his name.

**TERMS:** All items subject to prior sale and change of price without notice. All crystal orders must be accompanied by check, money order or cash with payment in full.

**RUSH YOUR ORDER NOW TO**

**TEXAS CRYSTALS**

1000 Crystal Drive, Fort Myers, Florida

Dept. **S9**

Phone WE 6-2100

**FOR SHIPMENT VIA FIRST CLASS MAIL AT NO EXTRA COST ATTACH THIS ADVT. TO YOUR ORDER!**

FOR ADULTS ONLY!

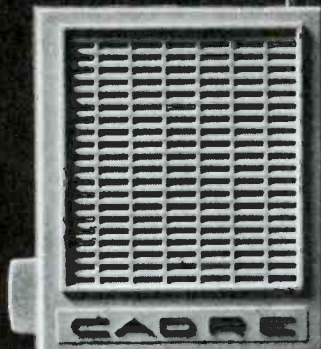

## NEW CADRE C-75 CB TRANSCEIVER

The new Cadre C-75 1.5-watt, 2-channel transceiver is 15 times too powerful for youngsters (under 18 years of age) to operate, according to FCC regulations. Clearly, it's not a toy. It's designed for serious CBers who need 'big set' performance that can be used conveniently anywhere.

The new C-75, weighing less than 2 lbs; provides clear, reliable 2-way communications up to 5 miles and more. All solid state design creates an extremely rugged transceiver to absorb rough handling, stays on frequency. Two crystal-controlled channels spell perfect communications contact everytime. Sensitive superhet receiver ( $1\mu\text{v}$  for 10 db S/N ratio) brings in signals in poor reception areas. Powerful transmitter has one watt output to the antenna. Adjustable squelch silences receiver during standby. AGC assures proper listening level. In a word, the C-75 has all the features you'd look for in a quality full size CB unit.

The C-75 has all the portable conveniences you'd want, too: operates on alkaline or mercury penlite cells (8-hour rechargeable nickel-cadmium battery available); earphone and antenna jacks; built-in retractable antenna; jack for base operation while recharging.

Use the Cadre C-75 anywhere in the field, for vehicle, office, boat or plane. Use it constantly too, because its all-transistor modular circuit (11 transistors and 2 diodes) is virtually maintenance free. \$109.95. Recharger and 2 nickel-cadmium batteries \$31.85.

### FOUR CADRE 5-WATT ALL-TRANSISTOR TRANSCEIVERS



5 crystal-controlled transmit and receive positions; automatic gain control, built-in squelch and noise limiting are just a few of the features.

**CADRE 510** Features variable tuning in addition to crystal control. Power supply for 110 AC and 12 volt DC. \$209.95  
**CADRE 515** Has a power supply for 110 volt AC and 12 volt DC. 5 crystal-controlled channels. \$194.50

**CADRE 520** For DC mobile operation and fleet use. \$187.50

**CADRE 525** In portable case with built in battery power supply, recharger, AC cord, telescoping antenna. \$269.95

Ready for CB? It makes sense to go CB with Cadre. See your Cadre distributor or write:

 **CADRE INDUSTRIES CORP.**  COMMERCIAL PRODUCTS DIVISION  ENDICOTT, NEW YORK  AREA CODE 607, 748-3373  
Canada: Tri-Tel Assoc., Ltd., 81 Sheppard Ave. West, Willowdale, Ont. Export: Morhan Exporting Corp., 458 Broadway, New York 13, N. Y.

# SHARPEN THAT RECEIVER!

## INCREASE SELECTIVITY WITH THIS SIMPLE MODIFICATION

by JIM KYLE, KEG3382

Somebody—I disremember just who it was—once said the true measure of a radio receiver of any kind was *not* what it would receive, but what it would *not* receive.

He meant, of course, its ability to reject unwanted signals, and to peel the signal you want to hear out from under several dozen layers of interference. And in that sense, the statement is emphatically true for

CB today.

With the ever-increasing number of units on the air, the old luxury of using only alternate channels has long since become impossible in populated areas, and is rapidly becoming impractical nearly everywhere.

But the ability to use every channel is usually impaired by the strong tendencies of most receivers to respond nicely to sig-

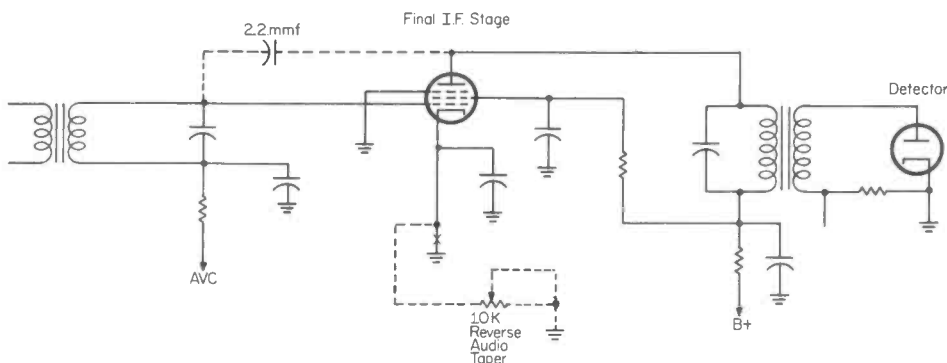

Fig. 1—Typical Circuit With Modification



nals on channels 8 and 10, when tuned to channel 9. And so forth.

This problem is nothing new. Quite some time ago it gave rise to introduction of dual-conversion adapters, and these usually help.

But there's a much less expensive and often better-performing answer, which you can add to your set in an hour's time for a total cash outlay of less than \$2. We call it "channel sharpening."

Figure 1, the schematic diagram of the last IF stage of a typical set, shows all there is to show of the modification—but before we go into the how-to-do-it in detail, let's see what you can expect from this in terms of your own operation.

There's no way we can keep from getting a little bit technical about all this, but bear with us—it won't hurt much. Figure 2 shows

will hear the unwanted signal. Rejection *greater* than 60 DB simply provides a safety margin.

Now let's look at the dotted line marked "Typical 1600 kc IF Response." This also applies to single-conversion units with intermediate frequencies between 1500 and 2000 kc, with minor variations in line position. Notice that adjacent-channel rejection is only about 30 DB—just half as good as required.

Most double-conversion units have a final intermediate frequency in the neighborhood of 262 kc, which provides quite a bit of improvement in the response as the dashed line shows (455-kc systems fall midway between these lines). However, at the adjacent-channel frequencies these are still only about 50 DB down, 10 DB short of the engineer's goal. The result? You can still hear the fellow on the next channel if he is strong enough.

The solid line, on the other hand, shows a possible result after addition of the Channel Sharpener to a 1600-kc unit. We have to say "possible" since, with the Channel Sharpener, you can select any degree of sharpness you need between this super-narrow (actually too narrow for use) value and the full width of the channel before the modification was made. Thus when no one is operating "next door" you can leave the receiver operating at full bandwidth, yet when interference is present you can "shave it off" unless it's right on channel with you.

What is all this? Basically, it's similar to the "Q Multiplier" used for years in some other communication services. The major difference is that this is built into your unit rather than being an outboard device requiring additional power. For the benefit of the technical wizards among the readership we'll say that it uses controlled regeneration in the final IF stage and let it go at that.

The modification, as you can see by Figure 1, is simplicity itself. You simply add a 2.2 MMF capacitor from grid to plate in the final IF stage, then lift the end of the cathode resistor from ground and connect it to a 10,000-ohm variable resistor.

This variable resistor becomes your "selectivity" control. Near the maximum-resistance position, bandwidth and selectivity

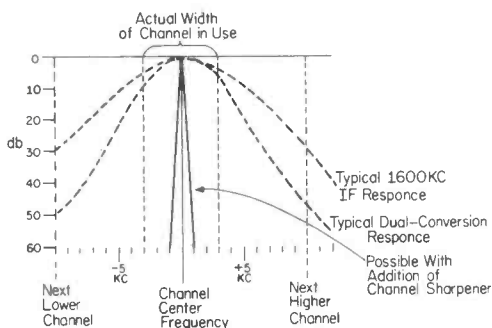

Fig. 2—Typical Selectivity

a group of "selectivity curves" for various equipments. The solid vertical line in the center of the picture represents the center of the channel to which you're tuned, while the vertical dotted lines at either side represent the centers of the next higher and next lower channel (assuming the usual 10-kc channel separation—some channels have a 20-kc interval). The vertical scale at the left measures "DB" or decibels, which are simply a conventional unit of measuring signal strength. Six DB normally are equal to one "S-unit" of signal; we set the zero-db point arbitrarily at the center of the channel to which we are listening, and the db units then measure how much we are rejecting out-of-channel signals.

Communications engineers have determined that, for maximum signal rejection, we must be sure of cutting down the signal we want to reject by 60 DB. Rejection of less than 60 DB means that sometimes we

will be similar to that you had prior to modification. As the control's resistance is made lower and lower, the bandwidth becomes narrower and narrower, until at some point as you approach minimum resistance the set will begin to oscillate.

The oscillating position can be handy if you want to receive sideband stations, but usually is something of a headache. It won't damage your receiver, but the shrill whistle on every strong signal and total lack of weak signals (the oscillation affects the automatic volume control circuit of the receiver just as if it were a very strong signal) may harm your nerves slightly. The cure is simple—adjust the control for slightly more resistance!

Finding a place to locate the "selectivity" control on the panel may prove to be a problem. On the HE-20 I converted, I removed the "squelch" control (replacing it by a fixed resistor set for no squelch action) since I never used it, and used this panel hole for the "selectivity" pot. If you don't have a control you want to sacrifice this way, you might investigate the possibility of replacing say the audio volume control with a "concentric" control such as are used in newer TV sets, and putting the "selectivity" control in as part of this assembly.

Making the modification as shown in Figure 1 may affect the S-meter readings of the set also. In particular, a modification of this sort on an HE-20 will make the S-meter almost inoperative. While it's possible to alter the modification to eliminate this problem, it's hardly worth the effort since the S-meter reading will have little meaning anyway. The "selectivity" control also controls RF gain of the set, so that an incoming signal would read several S-units higher in the sharp position than in the broad, even though its actual strength never changed.

Purists may object to these minor idiosyncrasies of this circuit—but I have found it well worth the time and small effort. I have not yet found a set with which it will not work—although a few sets with tunable receivers may turn out to have far more drift than owners now suspect, when coupled to a really sharp IF strip such as this. If this happens to you, just broaden out the selectivity a bit—or use crystal-controlled reception!

S9

## HE'S A QUIET MAN

(and a skinny one)

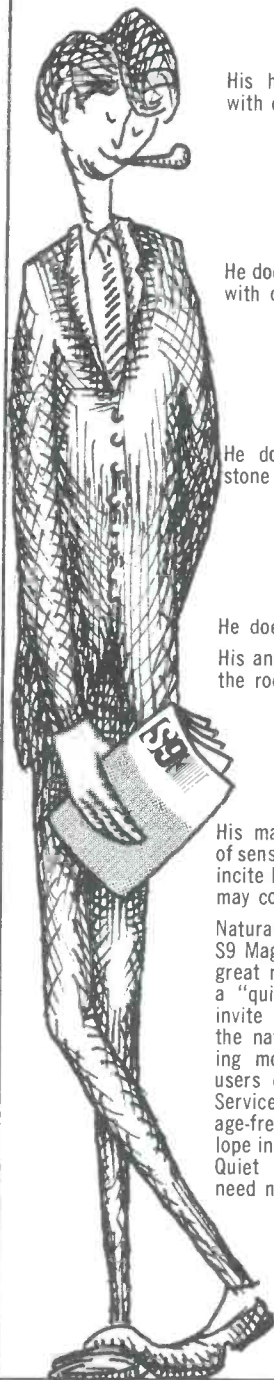

His hair isn't slicked down with chicken fat.

He doesn't wear raunchy suits with chrome lapels.

He does not wear a rhinestone stickpin in his tie.

He doesn't work illegal skip. His antenna is 20 feet above the rooftop.

His magazine does not reek of sensationalism, it does not incite him to do things which may cost him his CB license.

Naturally, he subscribes to S9 Magazine. If you, like the great majority of CB'ers, are a "quiet man" we cordially invite you to subscribe to the nation's largest circulating monthly publication for users of the Citizens Radio Service, S9. There's a postage-free subscription envelope in the back of this issue. Quiet men, unite! Rowdies need not apply.

S9

# CB TUBE SUBSTITUTION DIRECTORY

## 381 REPLACEMENTS FOR THE MOST POPULAR CB TUBES

by STEPHEN DEDALUS, 12W5415

CB rigs have the most uncanny knack of dropping dead at just the wrong moment—such as when you are just about to take a long motor trip, or (horrors) when you are in a small town where the only service shop within 100 miles never even heard of CB.

The most common problem you will probably ever have with your CB rig is when a tube “goes west,” except, of course, you have a transistorized rig. Chances are, like the great majority of rigs today, yours is of the tube species.

Anyway, when the only 6U8A with a hundred miles goes up in smoke, what can be done about it? Or what happens if your base station pops a tube on a Sunday, or in the evening after the service shops close up? Or what happens if your local shop is open, if he knows about CB, but he is temporarily out of the one tube you need? Do you convert your CB rig into a boat anchor? Do you consider switching over to smoke signals as a means of communications? If that's what's troubling you, Bunky, S9 has the solution with this handy guide of almost 400 direct substitutions for popular CB tubes.

Now if “Old Nell” blows a tube you can swipe one from your TV or Hi-Fi set until another of the original type can be obtained at the nearest tube emporium. Whatsmore,

if you're stuck in the boondocks where the local service shop doesn't carry the tube you need, you can shake the S9 CB tube substitution chart in the guy's face and make his come up with something (anything!) that will get you back on the megacycles.

The substitutions on our chart are all *direct* substitutions and will require no rewiring work on your rig. Substitutions in parentheses are to be used only as a last resort, when all other possible tubes are unavailable; they just won't give you anywhere near the performance of the original tube, but they will do a heckuva lot of a better job than the dud tube which you just threw angrily into the round file.

Tubes shown in **bold face** type are equal to, or in many cases better than, the tube which they replace. These tubes, on our list, include special industrial type tubes used in missiles, computers and other precision electronic gear. Their advantages usually include ruggedized construction, extra long life, and the fact that the tube will die *suddenly* when “it's time to go,” rather than die away slowly giving you inefficient operation for months (as is usually the case with “standard” tubes). Be prepared to spend a few extra sheckles for some of these industrial version tubes,

*Continued on page 51*

### S9 CB TUBE SUBSTITUTION CHART

ORIG.	REPLACE WITH
0B2	<b>6074 6627</b>
0C3	VR-105
5U4	<b>U52</b> 5AR4 5AS4 5AU4 5AW4 5AX4 5AZ4 5DB4 5R4 5T4 5V4 5W4 5Y3 5Z4 <b>5931</b>
6AK5	EF95 6AG5 6AH6 (6AJ5) 6BA6 6BC5 6BH6 6BJ6 6CB6 6CB5 6CE5 6CF6 6CY5 6EA5 6EV5 <b>#62</b> 403B 1220 5590 <b>5591 5595 5654 6096</b> <b>6968</b> (9001) 9003
6AL5	D717 EB91 6EB5 <b>5726 6058 6097 6663 7631</b>
6AQ5	EL90 (6BF5) <b>6BM5 6005 6094 6095 6669</b>

6AU6 EF94 (6AG5) (6AJ5) (6AK5) (6AK6) 6BA6 6BD6 #675 (5590) (5591)  
 5749 6136 7543 (9001) (9003)  
 6AV6 EBC91 6AQ6 6AT6 6BK6 6BT6 6066  
 6AW8 6AU8  
 6BA6 EF93 6AL5 6AU6 6BC5 6BD6 6CB6 6CG6 #675 5749 6136 6660  
 6661 7496 7543 9003  
 6BC8 EF93 X155 6BK7 6BS8 6BQ7 6BX8 6BZ7 6BZ8 6HK8  
 6BD6 6BA6 6CG6 #675 5749  
 6BE6 EK90 6BY6 6CS6 5750 5915 6660 7036 7502  
 6BH6 6AW6 (6BC5) 6CB6 6CF6 6DC6 #62 6265 6661  
 6BH8 6AU8 6AW8 6BA8  
 6BJ6 6AS6 6BA6 (6BC5) 6BH6 #625 6662 7694  
 6BJ8 6BN8  
 6BK7 X155 6BC8 6BQ7 6BS8 6BX8 6BZ7 6BZ8 6HK8  
 6BN8 6BJ8  
 6BQ5 EL84 N709 7189 7320  
 6BQ7 ECC180 X155 6BC8 6BK7 6BS8 6BX8 6BZ7 6BZ8 6HK8  
 6BS8 X155 6BC8 6BK7 6BQ7 6BX8 6BZ7 6BZ8 6HK8  
 6BZ6 6CB6 6DC6 6DE6 6DK6 #62  
 6C4 EC90 (6AV6) (6BF6) (6BK6) (6BT6) (6BU6) 6100 6135 (9002)  
 6CB6 EF190 6AG5 (6AJ5) 6AK5 (6AN5) (6AS6) 6AW6 6BC5 (6BH6) 6BZ6  
 6CF6 6DE6 6DK6 6HQ6 #62 5590 5591 5654 6676 7732 (9001) (9003)  
 6CF6 EF190 6AG5 (6AJ5) 6AK5 6AW6 6BC5 6BH6 6BZ6 6CB6 6DC6 6DE6  
 6DK6 5590 5591 5654 (9001) (9003)  
 6CL6 2014 6197 6297 6677  
 6CW4 6DS4 7895  
 6CW5 EL86  
 6CX8 6EB8  
 6CZ5 6DT5 6DW5  
 6DC6 6AW6 6BH6 6BZ6 6CB6 6CF6 6DE6 6DK6 #62  
 6DS4 6CW4 7895  
 6EA8 6GH6 6GJ8 6U8A  
 6EH7 EF183 6EJ7  
 6FY5 EC97 6ER5  
 6GH8 6AX8 6EA8 6GJ8 6U8A  
 6GW8 ECL86  
 6J6 ECC91 5844 5964 6030 6045 6099 6101 6927 7244  
 6RHH8 6DJ8  
 6T8 6AK8 6R8  
 6U8A ECF82 6AX8 6BL8 6EA8 6GH8 6GJ8 1252 6678 7731  
 6X4 EZ90 U707 6AV4 6BX4 5993 6063 6202  
 12AQ5 12BM5  
 12AT7 B739 ECC81 12AU7 12AV7 12AX7 12AY7 12AZ7 12BH7 12DF7 6060  
 6201 6671 6679 7492 7728  
 12AU6 HF94 12BA6 12BD6 #1275  
 12AU7 B749 ECC82 12AT7 12AV7 12AX7 12AY7 12DF7 5814 5963 6067 6189  
 6680 7318 7489 7730  
 12AV7 12AT7 12AU7 12AX7 12AY7 12AZ7 12BH7 5965 6829  
 12AX7 B759 ECC83 12AD7 12AT7 12AU7 12AV7 12AY7 (12AZ7) 12BH7 12BZ7  
 12DF7 12DM7 12DT7 5721 5751 6057 6681 7025 7494 7729  
 12AY7 12AT7 12AU7 12AV7 12AX7 (12AZ7) 12BH7 12DF7 6072  
 12BA6 HF93 12AU6 12BD6 #1275  
 12BH7 12AT7 12AU7 12AV7 12AX7 12AY7 12AZ7 12DF7 6913  
 12BY7 EL180 12BV7 12DQ7 7733  
 ECC83 12AX7 12DF7 5721 5751 6057 6681 7025 7494 7729  
 EZ90 U707 6AV4 5993 6063 6202



# TOM KNEITEL'S NEW BOOK!

for all CB'ers, Hams, SWL's Experimenters

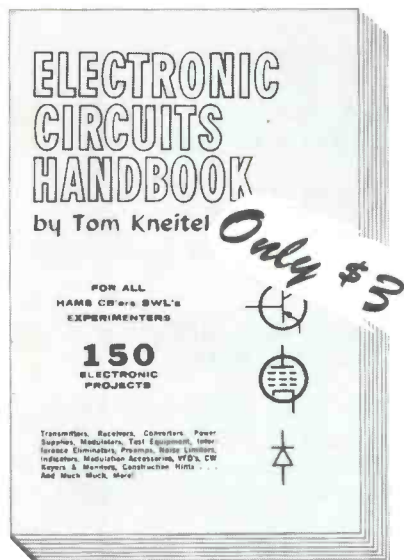

Here it is! The 150 most often needed circuits around a radio shack! Simple transmitters, receivers, preamps, converters, noise limiters, test gear, dummy loads, modulation boosters, interference eliminators, power supplies, and much, much more! Plus hints on how to turn rough construction jobs into fun! Each circuit is fully illustrated with a schematic and complete text!

This is the book you've been asking for, get your copy today from S9 Magazine, 300 West 43rd Street, New York 36, N. Y.

NYC residents add 4% sales tax

# FREE

Word sure gets around in the S9 crowd—we gave them out at the International Communications Fair and ever since then we've been swamped with requests from all over the country. Anyway, they're FREE as a reader service of S9—all you do is send us a stamped, self-addressed envelope (make it at least 7 by 10 inches if you don't want your certificate folded). Address your request to "Wall Certificate," % S9 Magazine, 300 West 43rd St., New York 36, N. Y. One to a customer, although clubs may request bulk amounts if an officer writes on the club letterhead.

If you throw in a paltry 25¢ per certificate, we will have your call sign boldly imprinted in large block letters on your certificate(s). Order as many as you like, but don't forget to send 25¢ for each one.



# you asked for it

# CB SOLDERING TIPS

by JOHN A. COMSTOCK

## PENCIL—DOZEN TOOLS

An ordinary mechanical pencil of the kind shown may become any one of a number of useful radio tools in just a couple of minutes. It may be used as a handy shockproof-burnproof holder for hot solder. Insert a small bit fashioned from a large paper clip and the pencil becomes a screwdriver for adjusting those small screws in transistorized radios, etc. Cut a small hook from the same paper clip and chuck it in the pencil and it is quickly converted to a dialstringing tool. A pipe cleaner converts it to a lube or solvent applicator.

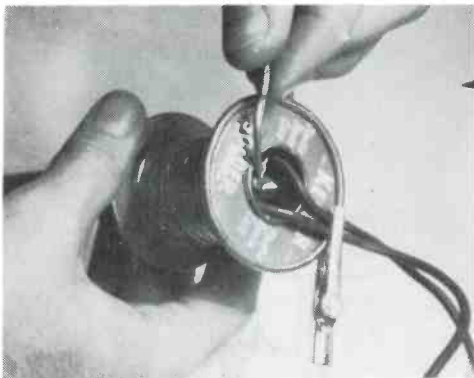

## SOLDERING THROUGH SPOOL TECHNIQUE

When the shop is cold or you have some wires to solder outdoors in the wind, use the technique shown. Put the spool of solder over the pencil tip and it will warm the solder and make it melt easier. Also, if you are soldering outdoors it will act as a shield and heat won't dissipate from the tip so rapidly. A test clip may be used to hold the work in the end of the spool conveniently.

## COLD SOLDER MELTS SLOWLY

Cold solder joints and slow melting solder in winter may be due to solder storage in a cold place. Before you tackle a soldering job, put the iron or pencil tip in the spool of solder while you wait for it to warm up. This will bring the solder up to at least room temperature for faster and proper melting. When a soldering gun is used, warm the solder in an oven, or over a lightbulb or hot-plate.

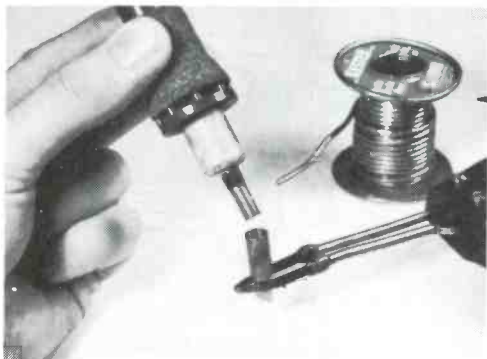

## PENCIL HEATING-POWER-BOOST

If you want your soldering pencil to work at top efficiency, tin the heating-element barrel for better heat transmission. One sure way of doing a good job is to wedge the pencil's tip in your soldering gun tip and drop in a little solder. Then when you turn the heated pencil into the tip containing solder, the melted solder will form a bond between itself and the tip and heating-element barrel. To change tips, plug-in the pencil and do it with pliers. Less convenience this way, but improved soldering efficiency with a hotter tip.

# SAVE \$28.95



**HAMMARLUND  
CB-23**  
with "S" Meter

ALL 23 CHANNELS  
READY TO GO

**ONLY \$5 DOWN / 3 YEARS  
TO PAY**

**Pay Only \$8.82 per Month**

## LOOK AT OUR DEAL!

Yes, if you purchase  
a New Hammarlund CB 23  
from us at the regular price . . .

WE'LL SEND YOU A NEW  
HY-GAIN CLR II  
FOR JUST \$1.00!!!

You save \$28.95 on the CLR II!



**HY GAIN  
CLR II  
Base  
Station  
Antenna**  
Only \$1  
with CB 23  
at regular  
price



**AMATEUR  
ELECTRONIC  
SUPPLY**

Send your mail order today to:  
3832 West Lisbon Ave., Milwaukee 8, Wisc.

- OK . . . ship me a CB 23 for \$249.50  
and a CLR II for just \$1.00
- Payment in full enclosed . . . YOU PAY SHIPPING
- I enclose \$..... I will pay balance:
- C.O.D.     1 Yr.     2 Yrs.     3 Yrs.
- 10% Down Payment

If buying on time payments see page 23 of this magazine  
for credit info.

**IF YOU HAVE TRADE, WE'LL GIVE TERRIFIC ALLOW-  
ANCE BUT THE CLR II DEAL WILL NOT APPLY . . .**

Give me your terrific trade-in deal on CB 23:  
I have ..... to trade, which was  
originally purchased as  Kit     Wired  
It originally sold for \$.....

I purchased it  New     Used  
**STAY ON AIR PLAN:** Keep on using present gear  
until new shipment arrives.

NAME ..... CALL .....

ADDRESS .....

CITY ..... ZONE ..... STATE .....

Send for free list of used CB and Ham Gear.

# MESS O' SCHMIDTS

by JACK SCHMIDT



"Who were you arguing with tonite?"



"And where is he supposed to put the mail for Mr. &  
Mrs. George Marshall?"



"Any room for your wife?"

# SAVE 15% on New CB Display Sets

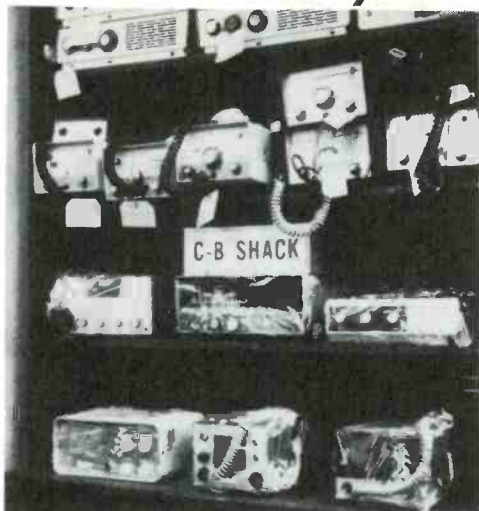

Pictured to the left is a typical citizen's band display such as that found in each of our stores and representatives' homes. The sets on the middle shelves, which are in plastic bags, are new display sets which have never been turned on, and, of course, are still complete with new guarantee, etc. So that the new display sets do not become outdated, we frequently offer them at a special price . . . This is one of those times. Save now. Of course, there is only one display unit at each of our stores and representatives' homes, so the quantity is limited. Act now—don't be disappointed. The others, not in plastic bags are reconitioned sets.

## "INTERESTED IN HAM RADIO?"

Surveys show that a lot of CB'ers eventually get their "ham" tickets. If this is your case, then here's a policy you will be more interested in. Within 12 months should you get a ham ticket, we will give you full purchase price for any CB set that you have purchased from us, when applied toward the purchase of any new ham equipment. The CB set you trade in must be free and clear.

### LOOK AT THESE VALUES!

	Regular price	New Display price	(payments after 10% down)	
			1 year	2 years
*Johnson Messenger II (with new tunable receiver)	\$169.95	\$144.45	\$11.91	\$ 6.50
*Johnson Messenger I	139.95	118.95	9.81	5.35
Polytronics SR-23	349.50	297.07	27.23	13.36
*Polytronics PC-N	189.50	177.17	14.61	7.97
Hammarlund CB-23	249.50	212.07	17.49	9.54
Hammarlund HQ-105TRC	229.45	214.53	17.69	9.65
*Hallicrafters CB-3A	159.95	135.95	11.21	6.11
*Hallicrafters CB-5	199.95	169.95	14.02	7.64
*RCA Mark VIII	149.95	127.45	10.51	5.73
RCA 6v DC or 12v DC supply for above	19.95	16.95	—	—

\*Note: Units with crystals are supplied with channel 11 installed. Extra channels are available at \$5.90 each for these units.

### DEALERS WRITE FOR OUR WHOLESALE PRICE LIST ON EQUIPMENT AND ANTENNAS

Important! Send all mail orders to Terry, 18W3516, Dept. S, Amateur Electronic Supply, 3832 West Lisbon Avenue, Milwaukee 8, Wisconsin.



## AMATEUR ELECTRONIC SUPPLY

**MILWAUKEE 8, WIS.**

**3832 West Lisbon Ave. • Phone We. 3-3262**

Hours: Monday and Friday, 9 A.M. to 9 P.M.  
Tuesday, Wednesday & Thursday, 9 A.M. to 5:30 P.M.  
Saturday, 9 A.M. to 3 P.M.



STEVE  
KHC6862

**CHICAGO 31, ILL.**

**6450 Milwaukee Ave. • Phone: Ro. 3-1030**

Hours: Monday, Wednesday & Thurs., 12 P.M. to 9 P.M.  
Tuesday & Friday, 12 P.M. to 5:30 P.M.  
Saturday, 9 A.M. to 3 P.M.



DOC  
(being assigned)

**ORLANDO, FLA.**

**23 Azalea Pk. Shop. Ctr. • Phone 277-8231**

Hours: Monday, Tues., Thurs. & Friday, 1 P.M. to 9 P.M.  
Wednesday, 1 P.M. to 5:30 P.M.  
Saturday, 9 A.M. to 5:00 P.M.



PHIL  
7Q1864

### ENCLOSE PAYMENT IN FULL AND WE'LL PAY SHIPPING CHARGES

- I Enclose Payment in Full— You Pay the Shipping!  
 I Enclose 10% Down—Will Pay Balance:  
 1 year                       2 years                       C.O.D.

1st choice .....  
 2nd choice .....

Send Extra Crystals for Channels ..... at \$5.90 a pair.  
 Need set for:  6v DC & 110v AC     12v DC & 110v AC

Note—No trade-ins accepted on the specially priced NEW DISPLAY SETS. However, if you do have something to trade, get our quote on new sets at the regular CB net prices.

I want to buy a new .....  
 and I want to trade a .....  
 which was originally purchased  
 in kit form                       wired  
 In this form this unit sold for \$.....

I purchased it                       new                       used

NOTE: WHEN YOU TRADE WITH US—YOU CAN KEEP YOUR TRADE-IN UNTIL YOU RECEIVE OUR SHIPMENT.

NAME ..... CALL .....

ADDRESS .....

CITY ..... STATE .....

Send free listing of used CB & Ham gear.



# NO BUGS

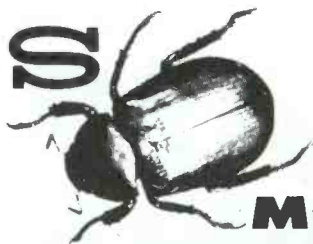

# IN MOSLEY ANTENNAS

## SCOTCH-MASTER

### UNI:LINEAR

Here is an Omni-Directional Vertical Ground Plane antenna which over shadows all other antennas of similar type available today . . . Why? . . . because of an extreme low angle radiation. A completely revolutionary matching system, featuring Grounded Element for lightning protection and drastic reduction of Rain Static Noise. These superior features combined with the world famous Mosley Construction assures the CB'er of an outstanding antenna for dependable communications.

**SPECIFICATIONS AND PERFORMANCE DATA:** Gain over standard ground plane - up to 4 db. VSWR: 1.5 to 1 or better over entire band. Feed Point Impedance: 52 ohm coax Unbalanced line. Assembled Weight: 8 pounds. Wind Load (EIA STD) 50 pounds. Antenna Height: Less than 20 ft. Number of Radials: 3. Antenna mounting fits masts up to 1½ inches OD

UL-27 . . . . . List Price \$45.80

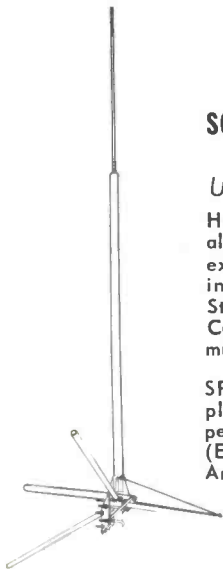

## SCOTCH-MASTER

Here are two beams for the CB'er who wants the best point-to-point communications at lower costs. Mosley SCOTCH-MASTER A-311-S, three element and A-511-S, five element beams are designed for the economy minded CB'er who wants the world famous Mosley quality.

### A-311-S

- No. of Elements - 3
- Antenna Weight - 12.5 lbs.
- Boom Length - 12'
- Maximum Element - 18' 8½"
- Front-To-Back - 20 db.
- Vert. Wind Load - 65 lbs.
- Hor. Wind Load - 35 lbs.
- Forward Gain - 8 db.
- Type Matching - Gamma
- Impedance Point - 52 ohms.
- Radiation - Uni-Directional

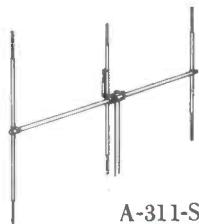

A-311-S  
\$35.00

### A-511-S

- No. of Elements - 5
- Antenna Weight - 16.5 lbs.
- Boom Length - 24 ft.
- Maximum Element - 18' 8½"
- Front-To-Back - 20 db.
- Vert. Wind Load - 112 lbs.
- Hor. Wind Load - 62 lbs.
- Forward Gain - 9.5 db.
- Type Matching - Gamma
- Impedance Point - 52 ohms.
- Radiation - Uni-Directional

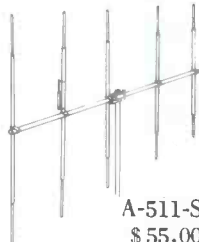

A-511-S  
\$55.00

## DELUXE LINE

### A-311

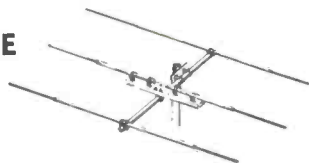

Dependable communications depend on the proper antenna system. Mosley's antennas are recognized for being tops in dependability. Mosley antennas, such as model A-311, are built of noncorrosive and rust-proof materials. All aluminum is heavy gauge 6061-T6, hardware is stainless steel and associated parts are expertly molded of durable plastic. Mosley antennas are designed for 52 ohm impedance.

A single A-311 beam, vertically mounted will give a gain in relative field strength of 8 DB over a reference dipole. This will increase the effective power of your CB transmitter to an equivalent of 32 watts.

A pair of A-311 beams, vertically, will give a gain in relative field strength of 11 DB over a reference dipole. This will increase the effective power of your CB transmitter to an equivalent of 63 watts Connecting transformer and stacking cable included with A-311 stacking kit.

A-311, 3 Element Beams . . . . List \$46.88  
A-311SK, Stacking Kit For Two A-311 Beams . . . . List \$68.21

**SO BUY Mosley**

*Electronics Inc.*  
4610 N. LINDBERGH BLVD.,  
BRIDGETON, MISSOURI  
Tell your friends about \$9



# ON THE COUNTERS

Tram announces a new addition to their line of top-notch CB rigs. The new unit, known as the TR-70C, is a 12 channel job designed to provide unrestricted use of the band. This version of the Tram 23 selects any of the 23 channels with a turn of a channel switch—the channel number appears illuminated on the front panel.



The receiver is tunable over the entire band and there is a socket provided on the front panel for a receive crystal if you prefer to monitor only one channel. The unit features an audio-visual spotting system.

The price of \$288 includes all crystals for 23 channel operation plus a Turner 355C. Since it is a mobile unit, it comes equipped for 6 and 12 volt operation. Tram's address is P.O. Box 187, Dept. B-8, Winnisquam, N. H., if you want full details.

International Crystal, 18 North Lee St., Oklahoma City, Okla. hasn't been sitting on their oars and resting after bringing out their ultra-unique Part 15 transceiver, the EXECUTIVE 1500. Here's what they have now.

First, they have a new innovation in electronic equipment called "Add On Circuits." These are all sorts of completed and wired circuits which go together in all sorts of clever combinations to produce transmitters, receivers, converters, etc. The "AOC" circuits used to produce these units include preamps, mixers, oscillators, IF amplifiers, detectors, FM discriminators, buffers, power amplifiers, modulators, frequency

multipliers, speech amplifiers, rectifiers, filters, regulators, power transformers, oscillator bridges. Prices begin at only \$2 per circuit. A chassis is also available for the mounting of several "AOC" circuits for the completion of a unit.

Two interesting books crossed our desk this month. The first is called "Understanding And Using Citizens Band Radio," and it's a rather complete guide to all aspects of CB. It's clearly written, practical and well worth the 50¢ it costs for more than 110 pages. Pick one up from Allied Radio, Dept. S9, 100 N. Western Avenue, Chicago 80, Ill.

The other worthwhile book is "Transistors, Theory and Practice," being distributed by Reed Advertising, 546 Pond Run Road, Raceland, Ky. It's a basic introduction to transistors, those little jiggers that are taking such an important part in today's electronics (including CB). Several practical transistor circuits are given in addition to a survey of data on many transistor types. The book is \$1.60 postpaid.



A new 10 channel CB rig employing a solid state frequency synthesizer is available from Raytheon, Distributor Products

# new and available now!

## "MESSENGER TWO" CB TRANSCEIVER



"TONE ALERT"



SELECTIVE  
CALLING  
SYSTEM

- 10 channels at flip of a switch — illuminated indicator!
- Increased sensitivity, high adjacent channel rejection!
- New . . . high efficiency noise limiter circuit!
- Provision for plug-in selective calling system!

Here's the new "Messenger Two" — with everything you've ever wanted in CB transceiver! Basic circuitry is patterned after the popular "Messenger". Highly efficient circuit design makes full use of maximum legal power . . . delivers a penetrating signal that "outperforms 'em all!" Looking for maximum receiver sensitivity? This unit is hot — pulls in signals you wouldn't know were around with less sensitive equipment . . . and adjacent channel rejection is tops! Tired of noisy receiver? New, noise limiter circuit in the "Messenger Two" lets you know what QUIET really means in a CB rig! Positive acting "squelch" and automatic volume control circuits — 10 channel coverage — push-to-talk microphone. Only 5 $\frac{1}{8}$ " x 7" x 11 $\frac{3}{8}$ ", easy to install anywhere.

Cat. No. 242-162 115 VAC and 6 VDC. . . . . \$169.95  
Cat. No. 242-163 115 VAC and 12 VDC. . . . . NET

5 CHANNEL "MESSENGER" TRANSCEIVER . . . Now at a new lower price, the big seller in the CB field! Excellent sensitivity and selectivity — punches out a power-packed signal! "Squelch" circuitry. . . . .  
Priced from \$139.95 NET

1 WATT AND 100 MILLIWATT "PERSONAL MESSENGERS"—Compact, 11 transistors and 4 diodes. Superhet receiver with exclusive tuned RF amplifier gives twice the sensitivity and 40% more range than similar units with conventional circuitry—more output than similar units with same rated inputs! Priced from \$109.50 NET

SEE YOUR DEALER-DISTRIBUTOR  
AND ASK FOR A DEMONSTRATION

BRAND NEW! A complete selective calling system with 37 different available tones!

The ultimate for any CB installation — designed for serious industrial, police and emergency use. Mutes speakers on your units until one calls another — then automatically your stations receive audio note and indicator light flashes "on", remaining lighted until call is answered. Eliminates annoyance of hearing "skip", electrical noise, or transmissions not meant for you!

- Not a kit, ready to go! Plugs into "Messenger Two", fast hook-up to your existing equipment!
- Sharp selectivity guards against random triggering which broad response units can't prevent!
- Wide range of tones permits 37 different systems to operate on the same channel without overlap. Plug-in reed locks unit "on # channel"—no missed calls due to "wrong" position on selector switches!
- Universal mounting bracket for left, right, or remote mounting under dashboard or desk!
- Tone signal heard beyond normal voice communication distance, increasing coverage by miles!

Only 1 $\frac{1}{2}$ " wide x 4" high x 7 $\frac{3}{4}$ " deep — wired with all cables and hardware.

Cat. No. 250-810 115 VAC and 6 VDC. . . . . \$59.95  
Cat. No. 250-811 115 VAC and 12 VDC. . . . . NET

FREE! 4-COLOR BROCHURE!



E. F. JOHNSON CO

® 7010 10th Ave. S.W. • Waseca, Minnesota

Please rush "Messenger" details to:

NAME \_\_\_\_\_  
ADDRESS \_\_\_\_\_  
CITY \_\_\_\_\_ STATE \_\_\_\_\_

Division, 411 Providence Turnpike, Westwood, Mass. The unit, the Ray-Tel TWR-3, provides 10 crystal controlled channels in addition to a tunable feature. It has a sensitive RF stage, a low internal noise figure, an "S" meter and a "tilt mounting base." Price is \$219.95. If you want more information, contact Glenn Foster at the company and he will give you personal attention if you tell him that you are an S9'er.

Hy-Gain Antenna Products, 8467 N.E. Highway 6, Lincoln, Nebraska, just brought out their new improved CLR-II base station antenna. It's a *complete* re-design job of their popular CLR model. The company claims 8 DB gain in all directions and backs this up with a guarantee that the CLR-II is "positively guaranteed to outperform any omni-directional base station antenna for Citizens Band." The unit features a rugged double grip mast mounting bracket which gives the CLR-II fantastic "staying power" in high winds. The net price of the CLR-II is \$29.95. Looks like a winner. Hy-Gain will send all S9'ers some fascinating comparative performance charts on this antenna up against other popular types. Write them!

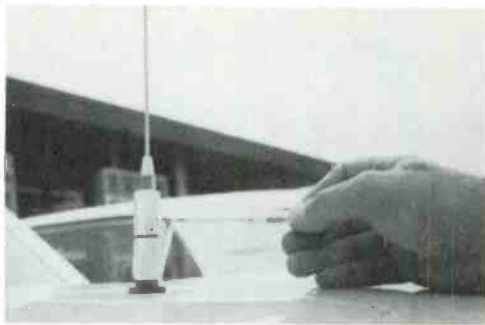

factorer claims that adds 1/2 to 3/4 watt output to your rig when it is tuned to 1:1 SWR. The antenna, known as the "Toroid-Tenna," lets you achieve the 1:1 SWR by means of a miniature toroid transformer tucked away in the base. The transformer is adjusted by means of a small screwdriver, there's no need to tune the antenna by the old "clip the tip" method. Made to military specifications, the whip has been two years in development by Electro-Winders.

Its standard PL-259 coax connector base makes for easy mounting, however a chrome plated universal mounting bracket is available at additional cost. The antenna goes for \$19.95.



The Webster Manufacturing Co., 317 Roebing Road, South San Francisco, Calif., has a new full-service CB rig wired for selective calling and primarily designed for heavy duty business use. The unit has 6 channels, an "S" meter and is smartly designed in a midnight blue finish on an anodized aluminum case, the unit being mounted in a "tilt" case. Jim Adams at the company will fill you in on further details at the drop of a card.

A new CB mobile antenna has arrived on the scene from Electro-Winders, Inc., 854 West First St., Covina, Calif. This one is quite different than others and the manu-

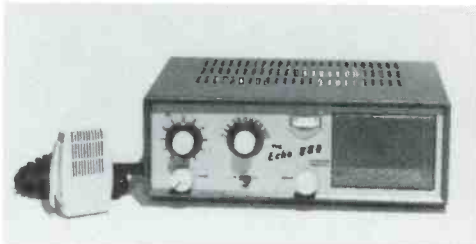

Sandy Wirth, our brother CB'er who runs Echo Communications, Inc. (Box 223, Cedarburg, Wisc.), has his own CB rig, effective this month. The rig is the ECHO 880 and it features 3 way power supply, dual conversion megacycle inhaler, 23 channel tunable receiver, 12 channels transmit plus external socket, "S" meter, crystal spotting, adjustable squelch and additional-gain type mike. The unit is priced "right". Sandy likes to read and answer mail, ask him about this rig and you'll probably get mail from him for the rest of your life. Sandy told us that he designed this rig after hearing the requests of CB'ers over the air and in his store for the past few years. He priced

*Continued on page 30*





**hy-gain** does it again

*...the new improved*

# CLR II

BASE STATION  
ANTENNA FOR  
CITIZENS BAND

- 8db Gain in All Directions
- Large Signal Capture Aperture
- Rugged Double Grip Mast Bracket
- Unique Static Arrestor
- Taper Swaged Seamless Aluminum Tubing
- Quickly and Easily Installed

Here's the most efficient omni-directional base station antenna ever made for Citizens Band... Hy-Gain's Model CLR II. It's a complete re-design of the history-making CLR Colinear - the world's original gain base station antenna for Citizens Band. The CLR II combines Hy-Gain design and production ingenuity with the experience gained from over 60,000 CLR's now in use throughout the world to bring you the highest performance base station antenna made. Every significant electrical and mechanical innovation that has a justifiable application is incorporated in the new CLR II. How good is it? The CLR II is positively guaranteed to outperform any omni-directional base station antenna made for Citizens Band... regardless of claims. When can you get a CLR II? You can get it now from your favorite Hy-Gain Distributor. It's priced at only \$29.95 Net.

**COMPARATIVE PERFORMANCE CHARTS  
CONCLUSIVELY DOCUMENT THE PERFORM-  
ANCE SUPERIORITY OF HY-GAIN'S CLR II!**

*Write for your copy today*

**HY-GAIN ANTENNA PRODUCTS CORP.**

**8467 NE HIGHWAY 6, LINCOLN, NEBRASKA**

*The World's Largest Manufacturer of Communications Antennas*

## NEW MECHANICAL SUPERIORITY

Structurally the CLR II is rugged. Every component part of the CLR II has been subjected to exhaustive and exacting laboratory and field testing to insure maximum durability.

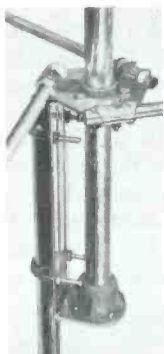

### RUGGED DOUBLE GRIP MAST BRACKET

A heavily ribbed, heavy gauge metal mast bracket binds the CLR II solidly to the mast. The 12" bracket provides two separate points of support to the bottom 12" of the radiator and the top 12" of the mast. Insures the CLR II will stand erect and secure at all times.

### TAPER SWAGED SEAMLESS ALUMINUM TUBING

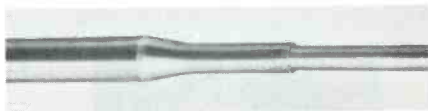

A new engineering design in tapering tubing that decreases wind load and gives added strength to the antenna. Strategically located swagings reduce the diameter of the tubing within inches as opposed to conventional gradual taper where comparable diameter reductions require several feet of linear distance. Reduced wind load allows CLR II to withstand gale-force winds.

### WEATHERABILITY

All metal parts are iridite treated to MIL specs. Molded high impact Poly-Styrene insulators impregnated with tough, durable fiberglass are totally impervious to weather. Insulators are mounted under compression... never under strain.

### INSTALLS QUICKLY

The CLR II is factory pre-assembled except for telescoping tubing. All tubing is factory pre-drilled and coded—no measuring required. Only minutes from carton to contact.

## NEW ELECTRICAL SUPERIORITY—8db gain in all directions

Performance wise, the CLR II delivers an unparalleled 8db of omni-directional gain—DOUBLES THE EFFECTIVE RADIATED POWER OF THE ANTENNA.

### 3.4db OMNI-DIRECTIONAL GAIN

3.4db of omni-directional gain in measured field strength intensity is achieved through using maximum legal aperture (greatest possible signal capture area). By using maximum legal height for the radiator (19' 10"), the radiator is electrically extended to  $\frac{3}{4}$  wave length. Full  $\frac{1}{4}$  wave length (9') horizontal radials provide a ground plane system. The  $\frac{3}{4}$  wave length radiator working against the  $\frac{1}{4}$  wave length ground plane system produces the lowest possible angle of radiation and directs the maximum amount of energy along the horizon for greatest possible range.

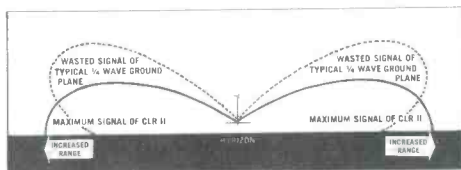

### 6db CIRCUIT GAIN

6db gain in improved signal-to-noise ratio is accomplished with Hy-Gain's unique built-in static arrester. Prevents static build-up and greatly reduces atmospheric noises in the receiver. Reduction in static build-up results in gains in signal-to-noise ratio of 6 to 20db. Additionally, the static arrester minimizes lightning hazard to the antenna and your equipment.



### NEW SOLID STATE MATCHER

New moisture-proof Solid State Matcher is permanently weather protected. Recessed 52 ohm coax cable connector is imbedded in a moisture-safe housing to insure against electrical failure. SWR is less than 1.2:1.

HERE'S WHAT THEY'RE SAYING!  
Not about

# The Bird ARTS & Coming!



But about S9:

"Move forward to subscribe with great vigah."

... Joan S. Kannadie

"I heartily agree."

... Larry Goldwater

"World's greatest publication."

... Tom Kneitel's XYL

"I never Met anything better."

... K. C. Stingle

"It's crummy."

... Armenian Corn Bread Addicts (ACBA)

"Better than even a nectarine."

... The 3000 year old man

"Eee-ucchh!!!"

... S4½ Magazine

"Couldn't get along without it."

... FCC (Findel's Clothing Corner)

"After a good revolution I always like to sit back and light one up."

... Fardel Casco

"Enough already! Quit kidding around and tell those guys to subscribe pronto! S9 is the only publication which gives a CB'er all the information he needs and wants. That's why S9 has the largest circulation in CB!"

... S9 Circulation Manager

postage-Free subscription envelope in the back of this issue.

Continued from page 27

it at a level which is "realistic in today's market and well within the means of any CB'er."

One of S9's oldest supporters, Holstrom Associates, P.O. Box 8640, Sacramento, Calif., has increased their line by the addition of the Model AAA-1 "Audio-Aid-All." Added to any CB rig, the AAA-1 boosts modulation and aids reception. Inside the magical box is a zener diode clipper, two stages of selective audio amplification and an L/C filter to triple the talk power of the rig. All this is accomplished without exceeding 100% legal modulation. Price is \$10.99 in kit form and \$15.99 wired, a very good buy and well worth having at these



prices. Holstrom also makes their well known SK-4 receiver booster for Heath GW-12 transceivers (kit is \$8.99, wired it's \$11.99), the SK-3 receiver booster for Heath GW-10, GW-11 and other transceivers (same prices as SK-4), and the DP-2 antenna coupler/duplexer for running the car radio on the CB whip while the CB rig is on (kit form only, \$4.99).

Here's something you can try for. In our travels we came across a genuine pair of metal flyers wings, vintage 1940, from the "Hop Harrigan All American Flying Club." These are the only pair known to still be in existence and are therefore probably worth a fortune. Some lucky S9 reader who sends an inquiry to the "mystery" advertiser in this issue will get them. We won't say who this advertiser is so it's up to you to send out some inquiry cards and cross your fingers. Don't forget to say you're one of the S9 gang! Winner will be notified by mail. If the response is good, we may have another "mystery advertiser" give away a rare lapel button reading "North Scituate Old Home Day, July 4th, 1914." It is resplendent with gold stars and red stripes, a dilly!

# S9 Lab Reports

## TESTING INTERNATIONAL'S 100A & FREQ. SYNTHESIZER

One of the highly respected lines of CB transceivers is International Crystal's EX-ECUTIVE series. The latest equipment in this series is the Model 100A transceiver and its companion unit the International CB Frequency Synthesizer.

The 100A is strictly designed for quality communications; there are no frills, chrome finish, or useless circuits. What's inside is strictly designed to get a message through with maximum efficiency.

The receiver section is actually the heart of the unit. Employing double conversion with a 455 kc. second IF amplifier *and a crystal filter*. (The crystal filter gives the necessary steep sided selectivity.) Selectivity is extremely good; when tested on channel

*Continued on page 53*

## CB Owners: IT'S WHAT GOES OUT ON THE AIR THAT COUNTS!

Get maximum amplifier output and outstanding performance from your 5-watter by using famous PR CRYSTALS. These high-active crystals get greater distance than ordinary sluggish crystals. Clearer reception too. Put PR Crystals in your set today, and get the STRONGEST SIGNALS POSSIBLE WITHIN POWER LIMITS.

### SWITCH TO A BETTER CHANNEL

Be smart... have several sets of PR Crystals... two or three sets at least. Then you can switch channels at will, to avoid jamming. PR CRYSTALS ARE AVAILABLE IN ALL 23 CITIZENS BAND CHANNELS.

Type Z-9R, Calibrated .005%, \$2.95 each. EVERY PR CRYSTAL IS UNCONDITIONALLY GUARANTEED.

Get PR's Now From Your Jobber.

**PETERSEN RADIO CO., INC.**

2800 West Broadway  
Council Bluffs, Iowa



## WHY PAY MORE WHEN THE BEST COSTS LESS?

Do these mikes below look familiar to you? That's because they're two of the largest selling CB mikes in the country. More Turner 350C's are used as original equipment on CB than any other mike. And the 254C is its matched base station companion — specially designed for optimum dual operation.

**MODEL 350C-Ceramic-**  
Equipped with hanger button, dash bracket, 5-foot (extended) rubber-jacketed coiled cord.  
Response: 80-7000 cps.  
Output Level: -54 db.

**MODEL 254C-Ceramic-**  
Operates with on-off push-to-talk and lock switch. Cable is 7-foot, three conductor (one shielded) wired for relay operation.  
Response: 80-7000 cps.  
Output Level: -54 db.

Write today for  
complete specifications.



**MICROPHONE COMPANY**

945 17th Street N.E.  
Cedar Rapids, Iowa





## GROVE CB VALUES!!

- TURNER MIKE MODEL 254-C.** Fine performance, rugged durability. Bar on off switch and lever lock on off switch. The 254-C ceramic has a response of 80 to 7,000 cps: Output—54db. (Reg. \$23.50) SALE **\$10.99**
- 7 in 1 CB TESTER SIGNAL OPTIMIZER.** Checks antenna power in watts, modulation, field strength, antenna output, harmonics, SWR, Base and mobile antenna efficiency. (Reg. \$47.50) SALE **\$39.95**
- COMMAND SUPER III—3-Element Heavy Duty Beam mounts** vertically or horizontally. (Reg. \$30) SALE PRICE **\$11.99**
- GROUND PLANE SALE!!!** (GP-1) ea. (Disc. Model) Solid Alum. Radials. All Sales Final (6 or more—\$5.00 ea.) **\$ 5.99**

### GET ALL OF THAT SIGNAL OUT WITH LOW LOSS FOAM COAX CABLE

- RG58U 50 ft.—\$2.49 100 ft.—\$3.99
- RG8U 50 ft.—\$4.95 100 ft.—\$8.99

- AUTO ANTENNA SPECIALS.** 102 inch, stainless steel whip, single chain bumper mount and heavy duty spring, all for \$8.99.
- Same as above, but with double chain bumper mount. **\$ 9.99**
- FAMOUS MAKE Transistorized "S" Meter.** No. AVC loading. Can be left on for constant signal check. (Reg. \$13.88) SALE **\$11.88**

**GROVE ELECTRONIC SUPPLY COMPANY**  
4115 W. Belmont Avenue  
Chicago 41, Illinois Ph. 283-6160

Rush items checked

SEND FREE CATALOG OF GIANT CB VALUES

Name \_\_\_\_\_  
(please print)

Address \_\_\_\_\_

City \_\_\_\_\_ Zone \_\_\_\_\_ State \_\_\_\_\_



## MICROPHONE HOLDER

### FOR CB and other MOBILE RADIOS

For cars, boats, base stations . . . puts the mike where you want it . . . when you want it . . . on any metal surface. Heavy duty magnet really holds. Fits most mikes. No holes to drill, nothing to mount . . . all one piece, ready to go.

GC PART NO. 65-525 — Net 99c.

**99¢**  
NET

AVAILABLE FROM YOUR CB INSTALLER OR GC ELECTRONIC PARTS DISTRIBUTOR. If you cannot secure locally, write to GC ELECTRONICS, Dept. R-2.

GC ELECTRONICS 400 S. WYMAN, ROCKFORD, ILL., USA

32 • S9 • August 1963

9 interference from channels 8 and 10 was essentially non-existent. The overall sensitivity is good with lots of speaker volume. The squelch is very good, rather than being either all-in or all-out it can be set so a slight background noise is present, insuring that you know the gear is not set hard into squelch (which might not release on weak signals). The noise limiter is like any other, effective but not great.

The receiver is either two channels crystal controlled or variable tuned. Each crystal can be "rubbered"; that is, an individual ad-



justment is provided which slightly modifies the crystal's frequency to allow for off frequency operation of the received signal. In case you do not care for crystal control (since you have to remove the cabinet to change crystals) a modulated calibrator is provided which allows you to pre-set the reverse VFO to any channel which is in your transmitter.

The 12 channel transmitter utilizes a pinet output and delivers slightly more than 2.5 watts to the antenna. The modulation is particularly clean, and modulation capability is to 100%. To insure optimum modulation a modulation level control is provided (so you can vary the mike gain) and a calibrated front-panel lamp permits you to adjust the gain for best modulation (when the lamp flashes you have at least 85% modulation).

Either 115 VAC, 6, or 12 VDC can be used as the power source. The mobile supply is transistorized to insure long-term reliability. Instead of the usual fuse a circuit breaker protects the rig against overloads.

Constructionwise the transceiver is built solidly, and shows signs of attention paid to assembly.

*Continued on page 53*

*Tell your friends about S9*

# PART 15 CALLBOOK

We will be keeping this on a constantly revolving basis, calling on each call area every few months to bring it up to date with the latest additions. If you subscribe to S9 you will be assured of having a complete Part 15 callbook as we have no plans at present to issue these calls in one single volume.

Entire contents copyright 1963 by Cowan Publishing Corp.

Western	Ch	Atlantic	Ch
185-186 R. L. Bice, 7435 Sale Ave., Canoga Park, Calif.	20	296-298 P. Skidmore, RFD 1, Rockwood, Tenn.	A-H
187-188 C. LeBlanc, 715 E. Raleigh St., Glendale, Calif.		299-300 E. H. Miller, Rt. 5 Box 91-B, Fairmont, W. Va.	A-H
189-194 Carey & Son, 10 B Cottonwood, Waco, Texas	All	301-302 A. Miller, 1416 Franklin Ave., Clarksburg, W. Va.	All
195-198 D. L. Pearce, 8923 Santa Fe Spr. Rd., Whittier, Calif.	9	303-305 RR. Jordan, 127 E. Green St., Westminster, Md.	H
199-201 J. B. Walker, 8628 Fairbanks Dr., El Paso, Tex.	7	206 E. C. Elder, 208 2nd. Ave., Winchester, Tenn.	A
202-204 L. C. Ingram, 231 W. Blackidge, Tucson, Ariz.	7, 11	307-311 T. A. Harris, 2017 Spotswood Rd. Charlottesville, Va.	A
205 J. E. Stith, 1716 Van Court, Alamogordo, N.M.	B	312 C. H. Hayes, 2457 Kingsley Dr. Macon, Ga.	A
206-209 H. C. Williams, 1800 Court Ave., S. Pasadena, Cal.	9	313 R. M. Corr, 534 Corbin Ave., Macon, Ga.	A
210-213 W. C. Pearce, P. O. Box 56, Happy, Tex.	10	314-315 J. W. Mosley, 410 Chestnut Ave. N. W., Roanoke, Va.	A
214-216 J. E. Harbert, 1406A Hodges, Amarillo, Tex.	11	316-320 L. Garrett, 8107 Larcom La., Richmond, Va.	All
217-218 L. B. Parker, 1604 Elmen St., Houston, Tex.	11	321-322 G. W. Fleeman, Box 207, Milligan College, Tenn.	All
219 C. D. Johnson, Box 1031, Tulsa, Okla.	All	323-325 J. O. Peterson, 3007 Roanoke Ave., Newport News, Va.	A
220-234 Boy Scout Troop #108, 3405 W. B. Way, Muskogee, Okla.	7	326 B. Klein, 4113 Kathlam Ave., Baltimore, Md.	A
235-239 K. J. Brown, 1407 Ave., Denton, Tex.	A	327-329 I. Crowe, Box 52, Bon Air, Ala.	2
240-241 M. Ellis, 749 W. Glenn, Tucson, Ariz	7	330-331 E. C. Shelton, 91/2 Pepper St., Christiansburg, Va.	11
242-249 D. M. Pate, Rt. #2, Durant, Okla.	7, 11	332 C. F. Lawson, 239 Carrington Ct., Huntington, W. Va.	21
250 J. D. Stephens, 1208 10th. St., Shallowater, Tex		333 W. F. Doyle, 511 Corbin Terr., Macon, Ga.	A
251-255 J. MacFarlane, 10613 Orion, Granada Hls, Calif.	7, 21	334 C. F. Pite, 571 Corbin Ave., Macon, Ga	A
256-257 W. P. Pippin, 309 S. 8th. St., Henrietta, Okla.	18	335-336 J. P. Timme, 121 Oakland Ave., Chester, S. C.	A-H
258-259 M. R. Perkins, 1006 Portola Dr., Arcadia, Calif.	11	337-338 L. C. Dillingham, 1719 Rubio St., Chatanooga, Tenn.	A
260-261 F. Ortiz, 905 W. Walnut, Monrovia, Calif.	11	339 L. Campbell, Rt. 2, Winchester, Tenn	A
262-264 R. Cox, 7952 Primrosa Dr., Bueno Park, Calif.	A	340-343 J. Amacher, 105 Hillcrest Dr., Winchester, Tenn.	A
265 L. Lawrence, 1042 Donaway, Amarillo, Tex.	B	344 C. M. Creamer, Shenandoah Junct., W. Va.	11
266-271 J. W. Jones, 1818 Anderson Pl. SE, Albuquerque, N.M.	A	345 J. Stark, 119 Hilltop St., Morgantown, N.C.	A
272-273 J. C. Wyatt, 10819 Amery Ave., S. Gate, Calif.	9	346-348 L. D. Murphy, 1141/2 Wayside Circle, Lenoir, N.C.	7
274-275 J. F. Wyatt, 10819 Amery Ave., S. Gate, Calif	9	349 F. N. Motto, 2240 Warren St., Petersburg, Va.	A
276-277 J. M. Taylor, 5215 N. Willow, Bethany, Okla.	A, B	350 J. R. Meeks, 1109 B St., St. Albans, W. Va.	A
278-281 J. C. Harris, 3712 4th. St., Bay City, Tex.	A, B	351-352 E. L. Brooks, 610 Spruce Rd., Newport News, Va.	A
282-284 A. Wong, 3825-1/2 Stockbridge Ave., Los Ang., Cal.	9, 10	353-356 R. D. Sturm, 323 W. 12th. Ave., Huntington, W. Va.	5
285-286 J. D. Sparkes, 324 Arlington, San Francisco, Cal.	All	357-358 D. Mitchell, 443 Washington St., Morgantown, W. Va.	A
287-290 W. Strathnian, 14977 Hayland St, La Puente, Cal.	A-H	359-360 J. Cade, 1639 Jefferson Ave., Huntington, W. Va.	7
291-292 G. E. Hindman, 307 42 St., Lubbock, Tex.	A, B	361-362 J. Wagner, 231 S. Main St., Wake Forest, N.C.	7
293-296 L. A. Zink, Box 324, Storgis, S. D.	D	363-364 F. D. Marcum, 1807 Monroe Ave., Huntington, W. Va.	A
297-298 C. W. Scarborough, Rt. 2 Box 16, Ballinger, Tex	A, B	365 F. Spigner, 915 Gregg St., Columbia, S. C.	C, B
299-300 D. Parrott, P. O. Box 277, Idaho Springs, Colo.	F	366 S. Stockman, 2715 Wilmot Ave., Columbia, S. C.	C
301-302 W. S. Granger, 935 Virginia St., Vallejo, Cal.	10	367-368 W. J. Moler, Harpers Ferry, W. Va.	B
303-306 J. W. Carroll, 740 Holly ave, Imperial Beach, Cal.	A-H	369-371 C. T. Webster, RFD 1, Bear Creek, N.C.	A
307-308 G. R. Wescom 2316 Helena St., St. Luis Obispo, Cal.	A	372-373 H. V. Darcy, 6112 N. 31st. St., Arlington, Va.	A-H
309-310 T. Clair, 2013 3rd. St., Salena, Tex.	C	374-375 G. Board, 908 Staunton Ave., Roanoke, Va.	A
311-312 J. C. O'Brian, Fruitdale, S. D.	A	376-378 B. N. Bangs, 506 Johnson, Piedmont, Ala.	All
313-314 J. B. Bennett, 238 Elkwood, Imperial Beach, Cal.	A, H	379-380 D. Doernberg, 1842 Windemere Dr., Atlanta, Ga.	B
315-316 R. Hellitwell, 950 Adrian Way, San Rafael, Cal.	9	381-382 C. I. Lee, 5130 Nebraska Ave., Washington, D. C.	16
317-320 R. A. Scott, 830 S. Spring St., Los Angeles, Cal.	A, E	383-387 B. V. Leclare, 1209 N. 3rd. Ave., Knoxville, Tenn.	11
321-323 P. C. Remick, 6001 Annan Way, Los Angeles, Cal.	C	388-389 J. Bailey, Rt. 3, Heflin, Ala.	7
324-328 J. Polson, 8576 Santa Monica, Los Angeles, Cal.	C	390-391 W. L. Wentworth, Box 56, Sistersville, W. Va.	12
329-330 B. Rodriguez, 2326 W. 11th. St., Los Angeles, Cal.	C	392 R. Butler, 123 Hilltop St., Morgantown, N.C.	A
331-333C. J. Baylor, 5833 Hunt Dale, Long Beach, Cal.	A, D	393 C. Butler, 123 Hilltop St., Morgantown, N.C.	A
334-335 C. W. Lord, 4004 Clover La., Dallas, Tex.	16	394-397 H. Rowan, 219 Pennton Ave., Lenoir, N.C.	C
336-337 J. White, Box 5675, Oildale, Cal.	A	398-401 J. G. Hutchinson, PO Box 91, Pressman's Home, Tenn.	A
338-341 J. L. Capen, 720 S. Main St., Los Angeles, Cal.	A, E	402 J. Clayton, 1951 N. Woodrow St., Arlington, Va.	10
342-343 P. Stovall, 321 S. W. Dian St., Burleson, Tex	C	403-404 C. Fields, Box 261, Clendenin, W. Va.	4, 11
344-346 F. D. Noffsinger, 85425 Ave., Coachella, Cal.	C	405-408 J. E. Hopkins, Rt. 2 Box 268, Piedmont, S. C.	A
347-349 W. H. Raub, 1460 Capitol Ave., San Jose, Cal.	23	409 B. Blazek, 4112 Moss Rose Dr., Nashville, Tenn.	A, 10
350-351 B. Waren, 712 Nebraska Ave., Weslaco, Tex.	9, 11	410 B. Harrison, 2020 Olga Ave., Nashville, Tenn.	A, 10
352-355 W. V. McLaughlin, 8705 Glider Ave. Los Angeles, Cal.	A	411 C. Jones, 3104 Stafford Dr., Donelson, Tenn.	A, 22
356-360 W. P. Smith, 102 N. Brand Blvd., Glendale, Cal.	A	412 F. Cornell, 3106 Stafford Dr., Donelson, Tenn.	A, 22
361-362 R. Terrel, 734 W. Vanover, Tucson, Ariz.	A	413 S. Waller, 3105 Stafford Dr., Donelson, Tenn	A, 22
363-364 E. Bechtold, Box 553, Joshua Tree, Cal.	A	414-418 S. Gross, 914 Cherokee La., Signal Mt., Tenn.	All
365-368 W. E. Egelund, 7572 S. 1000 East, Midvale, Utah	A	419-420 J. Jennings, Woodbury, Tenn.	A
369-371 R. W. Bechel, 11781 Stuart Dr., Garden Gr., Cal	D	421-422 GEMyers, 185 N. Main St., Mount Airy, N. C.	11
372 H. Bartlett, 4916 Stearns, Long Beach, Cal.	A	423-426 N. H. Arnold, 1002 Garden Dr., Scottsboro, Ala.	A, B
373-376 P. F. Barber, 410 E. 4th. St., Santa Anna, Cal.	A	427-428 D. Guinn, 148 Harvey St., Clarksburg, W. Va.	9
377-378 J. Panik, 18201 Rancho St., Tarzana, Cal.	A	429 C. S. Merritt, 137 Harvey St., Clarksburg, W. Va.	9, 10
379 H. J. Clark, 2309 S. Hudson, Okla. City, Okla.	C	430 R. J. Whitney, 3402 Wilson Blvd., Arlington, W. Va.	All
380-381 I. S. Kelley, P. O. Box 415, Gardena, Cal.	A	431 S. Hart, 4217 Warren Rd., Birmingham, Ala.	7
382-383 R. S. Dutton, 3415 W. Bway, Muskogee, Okla.	A	432 G. Blum, 4342 Mtn. Dale Rd., Birmingham, Ala.	7
384-386 G. W. Bistard, 959 Cinnabar, San Jose, Cal.	16	433 J. Church, PO Box 88, Strasburg, Va.	D
387-388 X. F. Silva, 7740 Balboa, Van Nuys, Cal.	A	434-435 B. Siskin, 1165 Cumberland Rd., Atlanta, Ga.	A
389-390 T. G. Seibel, 1513 Pole Line Rd., Davis, Cal	A	436-437 Weber, 943 Swickley, Charlotte, N. C.	7
391-395 J. Feinstein, 1421 S. Glenville Dr., L. A., Cal	2	438 J. Magnum, 407 Durham Rd., Wake Forest, N. C.	A, B

# PART 15

# KORNER

by DEAN DETTON, NORTHERN 17

% S9 MAGAZINE  
300 WEST 43 ST.  
NEW YORK 36, N. Y.

Last month the S9 "Letters to the Editor" column ran a rather irate epistle from a Joseph S. Mackora of Hartford, Conn. Mr. Mackora expressed himself by calling Tom Kneitel, S9's Editor, "a louse" and went on to say that users of Part 15 units were "damn fools whistling or yakking on a handie talkie." Well Mr. Mackora has now and gone onto bigger and better things, notifying the FCC of his strong objections to Part 15 units invading and trespassing on to Class C radio control frequencies.

He filed his complaint in such a manner so as to have it go on the FCC books as a formal petition. The petition asks that the FCC remove the present authority for the Part 15 units to operate on *all* frequencies within their allocated 27 mc/s band, and that they be delegated to the Class D Part 19 channels.

PART 15 CHANNELS	
Channel A	26.995 mc/s
Channel B	27.045 mc/s
Channel C	27.095 mc/s
Channel D	27.145 mc/s
Channel E	27.195 mc/s
Channel F	27.235 mc/s
Channel G	27.245 mc/s
Channel H	27.265 mc/s

He demanded the withdrawal of the Part 15 units "immediately in the public interest" and for the successful use of radio control. We wonder if he displayed his eloquent vocabulary in all of his writings to the FCC. It would seem that if Mr. Mackora is to be the spokesman for the radio control interests using these frequencies, then the question arises regarding the possibility of sharing

## APPLICATION FOR FREE PART 15 STATION IDENTIFIER CERTIFICATE

To register your Part 15 "unlicensed" CB station with S9 and receive your special station identifier certificate, do the following:

- Fill in the application below, or facsimile if you don't want to cut your copy of S9.
- Enclose your completed application form together with a self-addressed stamped (5¢) envelope, in another envelope addressed as follows:

Part 15 Department  
S9 Magazine  
300 West 43rd Street  
New York 36, N. Y.

- Please do not request special identifying words for your station as all identifiers are issued in alphabetical rotation for ease of recording on our records.

## APPLICATION FOR PART 15 IDENTIFIER

Name: \_\_\_\_\_ CB Call: \_\_\_\_\_

Address: \_\_\_\_\_

City: \_\_\_\_\_ Zone: \_\_\_\_\_ State: \_\_\_\_\_

Part 15 Channel: \_\_\_\_\_ Type of unit: \_\_\_\_\_

No. of units: \_\_\_\_\_ Date: \_\_\_\_\_

Signature: \_\_\_\_\_

anything on a gentlemanly basis with these fellows. Any opinions?

The Commission dug out of mothballs a piece of rulemaking which originated back in November of 1961. This rulemaking would set down some Part 15 rules to govern the use of FM wireless microphones within the 88 to 108 mc/s broadcasting band. Although not specifically allowed under the present Part 15 regulations, these wireless mikes now seem to be gaining popularity in this band. The new proposed rule changes would require type approval of the equipment in use on these frequencies. It is expected that the rule changes will also include low power tele-metering gear which operates within this band.

<b>CENTRAL 1328</b>		<i>WILL SWAP CARDS!</i>
<b>WPE10BEX</b>		
Robert G. Vansteenburgh		
Route 1 I am a Cerebal Palsy Chase, Kansas U. S. A.		
Amateur Radio N-17 of 7-1	1963	Confirming your QSO at 2:15 P.M. CST
Ur <b>CH A</b>	Mc. <u>cw</u> -fone signals	RST <b>339</b>
Receiver: <b>HE20C</b>	Antenna: <b>WHIP</b>	
Remarks _____	PSE QsL Trx	

Here's a nice looking Part 15 card from Bob Vansteenburgh, CENTRAL 1328, of Chase, Kansas. Thanks for the card, Bob. Any of you other fellows have a Part 15 card you want to show off here? Send them in!

WAYNESBORO, PENNSYLVANIA	
Monitor 11	
<b>N-1575</b>	
Citizens Band - Part 15	
Part 19- K1C6119	GARY A. BAKER 50 E. FOURTH ST.

We're also showing a card from Gary A. Baker, NORTHERN 1575, of Waynesboro, Pa. Gary runs a modified Realistifone hand held unit with a 57 inch whip mounted on a 31 foot mast. He receives on a Lafayette HE-20C transceiver. Gary hangs out on Channel 11. A quote from Gary's letter says that he "digs S9 the most for both Part 15 and Part 19." Anybody wanting to work out a sked with Gary can contact him at 50 East 4th Street in Waynesboro.

**THIS MONTH'S BRAINWASHING: Subscribe!**

# ORDER NOW

## IMMEDIATE DELIVERY FROM STOCK

# CADRE

most Powerful  
Portable  
2-way  
Radio  
MODEL C-75

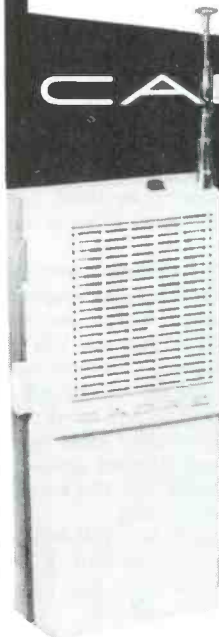

### INCOMPARABLE FEATURES

Two channel crystal Transmitter and Receiver • One-half watt of audio output power • Fully automatic overload protection • Two-tone high impact cabinet • Built-in, retractable antenna • Push-to-talk switch • Operates continuously up to 12 hours

• Complete with attractive carrying case, plus many other perfect performance features.



10% Down **\$11.00** (\$109.95)

ORDER NOW FROM HAMATEUR HEADQUARTERS

## THE Lew Bonn CO.

Distributors of Nationally Known Amateur Equipment

Dept. S9-463 67 South 12th St., Minneapolis 3, Minn.

Call, write or use coupon

Attn: Joe Hotch Federal 9-6351

- Place my order for scheduled delivery. Enclosed find \$ \_\_\_\_\_
- Send further details and literature on CADRE MODEL C-75

Name \_\_\_\_\_ Call letters \_\_\_\_\_

Address \_\_\_\_\_

City \_\_\_\_\_ Zone \_\_\_\_\_ State \_\_\_\_\_

August 1963 • S9 • 35



# CARD SWAPPERS UNLIMITED

Hey swappers, you aren't even giving us a breather. Last month you sent us what looked like a card from just about every swapper in the world and this month you went and "done it again." Most of the gang in this month's listings are new fellows and gals, not in last month's listings. So keep 'em coming! As we mentioned several times before, you can be listed each and every month if you like, all you have to do is send us a separate card for each month you want to be listed (it's the only way we can keep track of them in the office).

Have you applied for your swapper's awards? There are eleven different awards for card swappers being offered by S9 Magazine. Details for the awards were announced in S9 for July and will be announced again in S9 for September for those who might have missed them. If you can't wait, and if you don't have a copy of the July S9 handy, we will be happy to send you a copy of these rules upon receipt of a self addressed and stamped envelope from you. Don't forget to specify that you want a copy of the card swapper's awards rules.

The awards are really snazzy red, yellow and black and look very sharp up on the wall of the old shack. They measure 8½" by 5¾". You probably qualify for one or more of the awards.

Awards and copies of the awards rules are available from: "Swappers Awards," S9 Magazine, 300 West 43rd Street, New York 36, N. Y.

As we go to press this month we are receiving considerable mail for the awards. One S9'er, R. E. Olson of St. Paul, Minn., tells us that he has all 50 states, Washington, D.C., Puerto Rico, Venezuela, Guam and Canada. Another swapper, who doesn't want us to list his name till he gets a new supply of QSL's, said that he received about 300 cards as a result of his name appearing in the "Card Swappers Unlimited" section of the June issue.

Here's this month's group. Get your card into "Cardswappers" by August 15th so you can be in our October issue.

IQ2072 Harry Larabee, Box 252, Berrys Mills Rd., West Bath, Me.  
 IQ4224 Delmas Hastey, 41 River, Houlton, Me.  
 IQ4483 Chick Whiteside, 80 Hadley, Malden, Mass.  
 IQ6763 Bob Lawton, 26 Seventh, Medford, Mass.  
 IQ7315 George Brown, 24 Van Buren, Norwalk, Conn.  
 1W9494 Gary Sibulkin, 67 Trenton, Manchester, N.H.  
 2Q0602 Arthur Hamm, Church St., Philmont, N.Y.  
 2Q1911 William plog, 11 Gould Rd., Centereach, N.Y.  
 2Q3439 Tom Grimke, 1482 E. 95th. St., Brooklyn, N.Y.  
 2Q4574 R. L. Schappert, Wampus Ave., Armonk, N.Y.  
 2W4586 John Krejc, 40 Lanza, Garfield, N.J.  
 2W9739 Richard Ernst, P.O. Box 103, River Edge, N.J.

3Q0097/3 Bobby Covington, 1418 Okeloa, Boothwyn, Pa.  
 4W2406 Ed Keech, 905 Louisiana, Cumberland, Md.  
 5Q0577 Fred Harris, R. D. 3, Gate City, Va.  
 5Q1139 Claude Coggin, Box 634, Badin, N. C.  
 5Q3201 Bobby Glover, 815 Belmont, Wilson, N.C.  
 5W2109 Allon Clarke, 1009 Hamilton, Clifton Forge, Va.  
 5W2652 Theo Blankenship, Box 12, Rural Retreat, Va.  
 6Q0996 Robert Rose, 317 Clairmont Dr., Warner Robbins, Ga.  
 6Q5440 Joe Fleming, 52 Bailey Dr., Charleston Hts., S.C.  
 6W1936 Jack Powell, 1029 Airport Rd., Gainesville, Ga.  
 6W4731 Margaret Powell, 1029 Airport Rd., Gainesville, Ga.  
 9Q1209 Lee Lichtenstein, 130 E. Lynwood, San Antonio, Tex.  
 11A3260 Paul Colby, 327 E. Cedar, Burbank, Calif.  
 12W1890 Jim Conner, 2293 Alberta Dr., Napa, Calif.  
 15Q0284 Ronald Wagoner, Box 132, Helper, Utah  
 15Q0789 Dan Henville, 2002 Raton, La Junta, Colo.  
 16Q1018 Bob Metzger, 986 N. Avon, St. Paul, Minn.  
 16Q2299 Dick Becker, 618 Elfelt, St. Paul, Minn.  
 17Q3635 Bill Kennedy, 2135 N. C St., Fremont, Nebr.  
 17W5449 Henry Hawkins, 501 W. 10th. St., Kansas City, Mo.  
 18B2847 Donald Brown, Burgin, Ky.  
 18B2648 Glenn Davis, 6143 N. Rockwell, Chicago, Ill.  
 18Q0268 J. N. Rinehart, R. 2, Hagerstown, Ind.  
 19A5192 Ray Irwin, P.O. Box 153, Erlanger, Ky.  
 19Q4647 Howard Bruce, 320 Cedar, Wyandotte, Mich.  
 19Q7698 Chuck Cerny, 2393 Green Rd., Cleveland, Ohio  
 19Q9470 Adrian Fallert, 121 North C, Hamilton, Ohio  
 19QA0442 Art DeFrain, 226 S. 3rd., Harbor Beach, Mich.  
 19W8066 Fred Brown, 5759 Deering, Garden City, Mich.  
 20Q2247 Tom Fend, 945 E. Jefferson, Butler, Pa.  
 20Q3527 Frank Gibson, 254 Shearer, Butler, Pa.  
 20Q4011 Morris Kemmerer, R. D. #4, Box 426, Mountain Top, Pa.  
 20Q4332 Mabel Fend, 945 E. Jefferson, Butler, Pa.  
 20Q5209 Bernie Rosenson, 1225 Leeds, Monessen, Pa.  
 20Q4816 Frank Simpson, R. D. #3, Everett, Pa.  
 20W1572 Alvin Arthur, P. O. Box 27, Weymouth, Mass.  
 24W0818 Jerry Smith, 8116 Eastern Ave. N. W., Washington, D. C.  
 KAH8294 Ronnie Smith, 125 Hillside, Boone, N. C.  
 KBA1328 Ed Kupchunas, 28 Wood, Nashua, N.H.  
 KBA1852 Elmer Carpenter, 33 Cherry, Medford, Mass.  
 KBA3167 Jim Graham, 78 Washington Elms, Cambridge, Mass.  
 KBA3874 Fred Nowak, 2 Azalea, W. Peabody, Mass.  
 KBA4006 Joe & Flo, 16 Copland, Roxbury, Mass.  
 KBA4529 Robert Eaton, 27 Pond, Newburyport, Mass.  
 KBA4572 Alan Keer, 28 Belvidere, Boston, Mass.  
 KBA4717 Hal Danelio, 19 Sachem, Pinehurst, Mass.  
 KBA5302 Crummy Crumbacker, 42nd. FMS, Box 72, LoringAFB, Me.  
 KBA5494 Noma Eaton, 27 Pond, Newburyport, Mass.  
 KBA5557 Ted Cummings, Bellflower Rd., Billerica, Mass.  
 KBA6204 Ernest Morgera, 33 W. Eagle, E. Boston, Mass.  
 KBA6639 Dottie Burdette, 285 Brookline, Cambridge, Mass.  
 KBA2614 Cliff Smith, box 486, Block Island, R.I.  
 KBA7109 John Cull, 71 Bates, N. Abington, Mass.  
 KBA7339 Alex Jones, 102 Court, Houlton, Me.  
 KBA7367 Frank Franzosa, 23 Vista, Roslindale, Mass.  
 KBA7377 Bill Campbell, 117 Kinnaird, Cambridge, Mass.  
 KBA8563 Don Sullivan, 7 Ashford Terr., Alston, Mass.  
 KBB0287 Jim Gardner, 54 Tewksbury, Ballardvale, Mass.  
 KBC0112 Raymond Lemire, 24 Everard, Worcester, Mass.  
 KBC0298 Lana Wilson, Pearce Ave., Houlton, Me.  
 KBC0762 Deland Soule, 7 Bay Path, Kingston, Mass.  
 KBC0802 Thomas Quigley, 28 E. Eagle, E. Boston, Mass.  
 KBC1286 Mike Bessette, 45 Fairhaven Rd., Cumberland, R.I.  
 KBC1524 Rusty Rochette, 117 kinnaird, Cambridge, Mass.  
 KBC1607 Peggy Jones, 102 Court, Houlton, Me.  
 KBC1977 A. C. Masciarelli, P. O. Box 297, Clinton, Mass.  
 KBC2687 Roland McFalls, R. F. D. #1, Houlton, Me.  
 KBC3088 Wendell Dows, 279 Elm, Salisbury, Mass.

KBC3652 Phil Chandonnet, 246 Huse Rd., Manchester, N.H.  
 KBC4334 Joe Foster, 2 West St., Fairhaven, Mass.  
 KBC4669 Mary Govoni, 153 N. Quincy, Brockton, Mass.  
 KBG2994 John Conti, 575 W. Merrick Rd., Valley Stream, N.Y.  
 KBG4303 Tom Kneitel, 300 W. 43rd St., N.Y., N.Y.  
 KBG5659 Neil Hoffman, 116-22 Park La. So., Kew Gardens, N.Y.  
 KBG5786 Frank Pakay, 1279 Gurd Ave., Hillside, N.J.  
 KBG7070 Richard Ryder, 248 Feronia Way, Rutherford, N.J.  
 KBG7126 Larry Daniels, 5009 Broadway, N.Y., N.Y.  
 KBI1088 Stan Siegel, 88-10 32nd Ave., Jackson Heights, N.Y.  
 KBI1715 Johnny Lawrence, 27 Bedford Ave., Middletown, N.Y.  
 KBI3299 David Tringo, CMR 2319, Elgin AFB, Fla.  
 KCC3280 Ron Uzdavinis, 315 Woodbury Lake Dr., Woodbury, N.J.  
 KCC3299 Frank Dennys, 2712 Forwood, Chester, Pa.  
 KCC3352 Russ Wilson, 134 Highland Rd., York, Pa.  
 KCC3650 Ben Mosteller, 38 Walnut, Phoenixville, Pa.  
 KCD0117 Albert Fredrich, 421 E. 24th St., N. Wildwood, N.J.  
 KCD0207 Bill Ball, 7924 Rugby, Philadelphia, Penna.  
 KCD0796 Phil Mann, 2044 Chester Ave., Abington, Pa.  
 KCD1135 Frank Peterson, 1022 Old Farm Rd., Point Pleasant, N.J.  
 KCD1857 Tex Arnold, Shun Pike Rd., Cape May Court House, N.J.  
 KCF0823 Jim Cross, 755 S. Potomac, Hagerstown, Md.  
 KCF1908 Bob Rader, 226 Blackwell, Bridgeport, W. Va.  
 KCF2320 Charles Creamer, Rt. 1, Shenandoah Junction, W. Va.  
 KCF2420 Frank Williams, 74-A-MEMQ-NAS, Patzert River, Md.  
 KCF2541 James Lofton, 712 N. Loudoun, Winchester, Va.  
 KCF2574 Fay Benedict, 941 Corbett, Hagerstown, Md.  
 KCG0272 Carl Robey Sr., RFD #4, Box 532, Fairfax, Va.  
 KCG0290 Delbert Kriner, Rt. 6, Hagerstown, Md.  
 KCG0410 Henry Harris, Box 124, Charles Town, W. Va.  
 KCG0774 Lew Reinberg, 4118 Kathland Ave., Baltimore 7, Md.  
 KCG0888 Joe Himson, 224 Belmar, Morgantown, W. Va.  
 KCG1188 F. Everly, 31-B, Keyser, W. Va.  
 KCII1881 Pete Almond, 720 Hill, Albemarle, N.C.  
 KCI2592 Stanley Walker, R.F.D. 1, Waverly, Va.  
 KCI2904 Jim Rawles, 7008 Belvedere Dr., Newport News, Va.  
 KCI2948 Earl Paynter, 1001 E. Jefferson, Charlottesville, Va.  
 KCI5169 Charles Ford, 5926 Dorset Rd., Richmond, Va.  
 KCI6293 Howard Chopsyleya, 418 Virginia Ave., Norfolk 8, Va.  
 KCI6304 Charles Tusker, 4816 E. Seminary Ave., Richmond 27, Va.  
 KCI6631 Harold Williams, P.O. Box 1143, Newport News, Va.  
 KCI6875 Kirk Brown, 227 Wallace Ave., Wilmington, N.C.  
 KCI6907 Gaylord Worsham, 301 S. Fieldcrest, Draper, N.C.  
 KCJ0291 Ken Mills, 817 Lewis, Asheboro, N.C.  
 KCJ2269 Frank Anderson, 73 Bishop Ave., Danville, Va.  
 KCJ2292 Hazel Stubbs, P.O. Box 1076, Rockingham, N.C.  
 KDB0371 Bill Howell, Jr., 545 Palmetto Lane, Aiken, S.C.  
 KDB1102 Bill Gatfield, Rt. 1, Box 6, Dunlap, Tenn.  
 KDB1435 Daniel Guthrie, Box 362, Spruce Pine, N.C.  
 KDB1986 Buddy Downer, Rt. 2, Box 212, Aliceville, Ala.  
 KDB3106 Mack McClellan, 712 Hamlin, Kingsport, Tenn.  
 KDB3565 Carl McCall, Brevard, N.C.  
 KDB3762 Mike Ferrell, 2718 Edgewood Rd., Columbus, Ga.  
 KDB4538 Howard Tripp, 1821 Reynolds Ave., Charleston Heights, S.C.  
 KDB5061 Robert Park, Box 393, Robins AFB., Ga.  
 KDB6398 Mo. Turner, 2876 Briarwood Blvd., E. Point, Ga.  
 KDB6424 Billy Kemp, 2811 Lunda Lane, Columbus, Ga.  
 KDB7309 Robert Wood, 1625 Third Ave., Tuscaloosa, Ala.  
 KDB8247 Joe Buntyn, Rt. 7, Crossville, Tenn.  
 KDB8688 J. Bragg, Box 243, Crossville, Tenn.  
 KDB9503 Dolores Heming, 52 Bailey Dr., Charleston Heights, S.C.  
 KDD0309 Red Howard, 336 Meridian Ave., N. Augusta, S.C.  
 KDD0450 James Haney, Rt. 1, Box 295, Hendersonville, N.C.  
 KDD0464 Thomas Smith, 601 7th Ave., Athens, Ala.  
 KDD0748 Mike Jones, 711 Rollingwood, Aiken, S.C.  
 KDD1169 Keith Chrisman, 1840 Reynolds Ave., Charleston Heights, S.C.  
 KDD1453 William Harris, Station Hospital, Bainbridge, Md.  
 KDD1522 Don Huntley, Bat Cave, N.C.  
 KDD2015 Bernie Florie, 1731 Kissingbower Rd., Augusta, Ga.  
 KDD2173 Tom Watson, 502 S. Plymouth Rd., Huntsville, Ala.  
 KDD2499 Harry Deyton, Box 399, Caroleen, N.C.  
 KDD3270 Johnie Trawick, 708 Hull, Ozark, Ala.  
 KDD4120 Bobby McBay, 907 W. Bryan, Athens, Ala.  
 KDD4500 Faye Smith, 601 7th Ave., Athens, Ala.  
 KDI2523 Joe Yglesias, P.O. Box 5353, Tampa 5, Fla.  
 KDI0347 John Holmes, 1301 Palmer Terr., Jacksonville, Fla.  
 KEA2152 Donald Lowe, 14 Valley Dr., Little Rock, Ark.  
 KED0784 Jim Pearson, Rt. 3, Box 97L, Orange, Tex.  
 KED2032 Elton Smith Jr., 2318 S. College, Bryan, Tex.  
 KED2034 David Blackburn, 401 Ave., Wharton, Tex.  
 KE0235 Elton Smith, Sr., 3304 Riedel Dr., Bryan, Tex.  
 KED2477 Daniel Ginzler, Rt. 3, Box 55A, Bryan, Tex.

KEE0592 Terry Whittle, 1306 E. 27th, Bryan, Tex.  
 KEE0743 Chester Price, 808 Banks, Bryan, Tex.  
 KEE0767 Bob McMillan, P.O. Box 1072, McAllen, Tex.  
 KEG0314 Jerry Marshall, P.O. Box 178, Waynoka, Okla.  
 KEG1249 John Bales, 408 N. Ridge, Lampasas, Tex.  
 KEH0688 Jerry Stephens, Rt. 1, Box 96, Temple, Tex.  
 KEH0829 Billy Stith, P.O. Box 234, Atoka, Okla.  
 KEJ0733 Ed Grubgeld, P.O. Box 65, Solvang, Calif.  
 KEJ3801 Jack Bentley, 1060 W. 17th, Santa Ana, Calif.  
 KEJ5976 Mark Keller, 1326 N. Citrus Ave., Hollywood 28, Calif.  
 KFA0553 Gerald Gilbert, Box 142 340 F.M.S., Whiteman, Mo.  
 KFA0959 Joe Pall, 9108 Flower, Bellflower, Calif.  
 KFA1028 Thomas Martin, 1679 Manor Circle, Pomona, Calif.  
 KFA2330 Larry Merritt, 5303 Penfield, Woodland Hills, Calif.  
 KFC3905 Philip Oak, 41460 Malcolmson, Fremont, Calif.  
 KFC4049 Tom Weitzel, 216 17th, Pacific Grove, Calif.  
 KFC4344 Jack Green, 26973 Creole Place, Hayward, Calif.  
 KGB0117 King Hitz, 3212 Majestic Dr., Salt Lake City, Utah  
 KGB0764 Dick Church, 819 St. Mary, Casper, Wyo.  
 KGB1500 Wendell Starr, 2827 Bel Air Dr., Albuquerque, N.M.  
 KGE2630 Howard Lockert, 711 Sherburne Ave., St. Paul 4, Minn.  
 KGE2634 Wesley Jones, Sr., 970 E. Jessamine Ave, St. Paul, Minn.  
 KGF0210 Jim Hayes, 5436-26 Ave., Minneapolis 17, Minn.  
 KGF0272 Wesley Jones, Jr., 407 Compton, St. Paul, Minn.  
 KGF2923 Al Hansen, 4747 Terr., Kansas City 12, Mo.  
 KGH3247 Larry Anderson, Rt. 1, Box 71, Alta, Iowa  
 KGII798 Jere Bruning, RFD #2, Robinson, Kans.  
 KGIO109 Glenn Hinkle, 3018 Michigan, Kansas City, Mo.  
 KGIZ607 Hal Refield, 4406 W. Florissant Ave., St. Louis, Mo.  
 KHA1530 Tino Gordianer, 418 State, Quincy, Ill.  
 KHA3600 Leo Brooking, 1923 Clay, Paducah, Ky.  
 KHA4609 Otto Stierlin, Jr., 418 State, Quincy, Ill.  
 KHA5298 Wayne Shumway, 8347 Paxton Ave., Chicago 17, Ill.  
 KHA7824 Perry Stierlin, 718 Kentucky, Quincy, Ill.

**QSL'S by GARTH**  
*Nation's Largest*  
**From \$2.50 per 100 in 3 Colors**  
**Free Samples & Catalog**  
**Garth Printing Co. Jutland, N. J.**

KHBI722 Bill Wootan, New Whiteland, Ind.  
 KHB2036 Butch Hollenbeck, Box 7, Buffalo, Ind.  
 KHB3971 Larry Parkhurst, R.R. #1, Columbia City, Ind.  
 KHB4560 Stan Urbanski, P.O. Box 232, Michigan City, Ind.  
 KHCI607 Jim Cole, 830 N. 16th, Elwood, Ind.  
 KHC2566 Richard Kyler, Rt. #6, Columbia City, Ind.  
 KHC4311 Ken Hart Jr., 348 S. Harvard, Villa Park, Ill.  
 KHGI444 John Shields, 211 E. High, Cridersville, Ohio  
 KHGI821 Curt Jones, 214 S. Pierce, Galion, Ohio  
 KHG2346 Carl Brown, 119 E. Prospect, Alliance, Ohio  
 KHG9108 Harold Stafford, 1325 John, Kalamazoo, Mich.  
 KHG9404 Roy Cornwell, 723, W. Shiawassee, Lansing 10, Mich.  
 KHH0388 Jim Owen, 1408 Garland, Flint 3, Mich.  
 KHH0396 J. Klemm, R.R. 4, Wapakoneta, Ohio  
 KHH0584 Vern Stevens, 4943 Harding Ave., Ravenna, Ohio  
 KHH0641 Bob Danny, 918-23rd, Huntington, W. Va.  
 KHH1134 Roger Miller, Rt. #3, Russell, Ky.  
 KHH1622 Buzz, 8615 Salem Lane, Dearborn, Mich.  
 KHI2416 J. Oldaker, 602 Hagan, Huntington 2, W. Va.  
 KHI3106 Frank Marshall, 1220 4th S.W., Canton 1, Ohio  
 KHH3469 Wes Skowron, 30707 Marshall, Southfield, Mich.  
 KHH3585 Leon Breeze, 5660 Hipp, Dearborn 9, Mich.  
 KHH3701 Walter Love, 6837 Mayfair, Taylor, Mich.  
 KHIO340 Paul Ritz, 2544, Columbus Rd., Canton 5, Ohio  
 KHIO376 Henry Hutton, 211 Conrad, Webster Springs, W. Va.  
 KHII227 Roary Williams, 25462 Ivanhoe, Detroit 39, Mich.  
 KHII813 Mac MacLachlan, 13926 Fielding, Detroit 23, Mich.  
 KHJ2581 Tom Breeze, 5660 Hipp, Dearborn 9, Ohio  
 KHJ2909 Vern Allen, 801 E. Court, Sidney, Ohio  
 KHJ4110 Tom Moore, 252 W. 10th, Peru, Ind.  
 KHJ4670 Charles E. Nigg, 4174 Millville, Rd., Oxford, Ohio  
 KHJ6390 Carl Franklin, 223-26th Rear, Huntington, W. Va.  
 KIC0072 Bob Rogers, 227 Green, Pittsburgh 21, Pa.  
 KIC0212 Gerald Cowan, 400 Bremen Ave., Matydale II, N.Y.

*Continued on page 52*

# CB CASEBOOK

by LEE AURICK, 2W2870

MT. PLEASANT RD. RFD 1  
COLUMBIA, PA.

WOULD YOU LIKE TO READ ABOUT YOUR COMMERCIAL USE OF CB IN S9? IF SO, WRITE TO US.

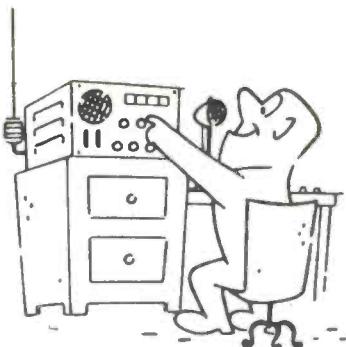

"It isn't the unusual things that cause me to be enthusiastic about CB. Rather, it's the fact that we pretty much handle everything as routine, now that we have our radios. Unusual things rarely happen anymore."

Ken Dockendorff, 1Q2918, owner of the Dockendorff Funeral Home, Limerick, Maine, was talking to your S9 reporter about CB radio, one of his favorite subjects.

"Limerick is a small country town with a large outlying area, so I'd say that saving miles is perhaps the biggest advantage that CB offers me. At the present moment I have one unit installed in my office, and another unit in my station wagon which I use as an ambulance.

"This part of Maine is quite hilly and it's not hard to get pretty good distance at times. Just last summer I was on duty with my ambulance at Gorham Raceway, at least twenty-five miles away, and I had solid contact with my base station at all times. My base station is located fairly high, and if I can choose a good hilltop when I'm on the road I can usually talk back to the office from forty or fifty miles away.

"CB is quite popular in this part of the state, and there is lots of activity on the air. But whenever my wife goes on the air and says 'Emergency,' everyone cooperates to immediately clear the channel. Often, I won't be in the best location to hear her, or to have her hear me. It's at times like this that the rest of the fellows on the band really show the stuff they're made of, and come to our assistance to relay the urgent messages. There was the time I was over on the New Hampshire-Vermont line, and was able to send and receive messages through a relay station, all in a period of ten minutes. In an area like this, where telephones are frequently few and far between, there just wasn't anyway to beat this speed.

"I have been instrumental in getting one of the town's lady doctors interested in CB, and we both feel that with a unit in her office and one in her car it will tremendously shorten the time that it takes me to respond with my ambulance. I am involved in many emergencies in which minutes may mean a life.

"You could call me 'A one man CB campaign.' I expect very shortly to establish radio contact with our local Fire Dept., and I already have it with one of our neighboring towns. Right now I am working on making contact with the State Trooper, resident in this area. We all feel that only CB radio can offer us the added measure of security and convenience we would like to have.

"A great deal of my time is spent on the road. Being able to reach my office, and have them reach me, enables me to run my business as if I were in the office, and still give better and faster service.

"CB radio has proved to be a real public service here, too. I have been out on hunts several times for people who were lost or

missing. As you might guess, these things never happen in broad daylight, or in good weather. They always seem to occur at night and in some kind of a storm. Patrolling dark country lanes and roads, under those conditions, is just the time you really begin to appreciate just how much CB radio means to you and everyone else in the community. During a hurricane, a year or so ago, I patrolled an entire section of the Old Orchard and Ocean Park coast, and still stayed in close contact with other CB stations monitoring the Hurricane Watch.

"But CB isn't limited to just business and community activities, the way I use it. As a member of the Odd Fellows, I have been able to contact other members and arrange dates for degrees and other Lodge activities. CB has been of great help in this area, and I believe we can expand even further in this direction, as more people come to an understanding as to the unlimited possibilities that CB offers.

"Several times, when I have been on my way to the hospital with an emergency patient, I have been able to contact a CB station near the hospital, while I was driving, and have this station alert the Emergency Unit

that I was on the way. It saved minutes each time, and very likely lives.

"My CB rigs get a lot of use in all of my activities; business, personal, and community. I guess what I really mean is that life 'Down East' would sure be different for me if I had to go back to the way things operated BCB (before citizen band).

"There is just one more installation that I'm planning for myself. As soon as I can find the right antenna, I'm going to install a unit on my Funeral Coach. I believe that at times this could be very helpful. Particularly in long processions, it would be helpful to have my other unit at the rear of the caravan, and to maintain contact with the Coach in the event that some delay was experienced en-route. I already order my cement vaults via CB. It saves a telephone call."

**\$9**



**CALL LETTER SIGNS**  
Order your call in neat 2-inch die cut letters with base. Just right for the shack. You assemble. Letters: 3/32" silver showcard stock. Base: Satin finish black plastic.

**Price \$1.50 Postpaid**

**NEW PRODUCTS Dept. C**  
Box 481 Grand Haven, Mich.

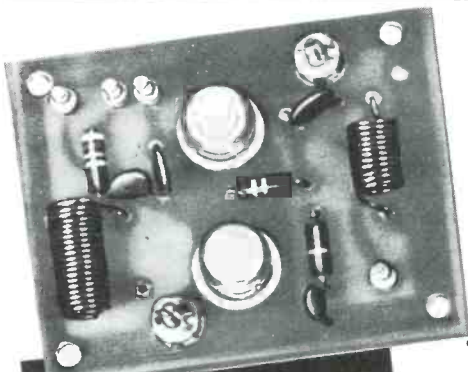

## 2-STAGE "CB" NUVISTOR PREAMPLIFIER

**GUARANTEED TO IMPROVE RECEPTION ON  
YOUR CB RECEIVER OR TRANSCEIVER**

- Finest Printed Circuit Board
- Wired, Complete with 2 RCA 6CW4 Nuvistors
- Can Double Sensitivity Over 20 db Gain
- Use with Superhet or Regen Units

• Actual Size — 2 3/4 x 2 3/16

**\$11.95**

## TWO "CB" SPECIALS FROM WRL

Receiver is specially designed, superhetrodyne circuit. 9-volt battery included. Push to talk switch.

Write for complete information  
Dealer inquires invited

## SPACEMATE TRANSCEIVER

The finest two-way radio on the market at this price

### FEATURES

- 2-way receiver and transmitter
- No license or test required
- 9 transistors plus one diode
- 1 or more miles range
- 46" telescope antenna
- Choice of channels 11 or 16

In Pairs, Each **\$29.95**

Single, Each **\$34.95**

**INCLUDED FREE** →  
leather case and strap, battery and earphone

**WRL**

**WORLD RADIO LABORATORIES**

3415 West Broadway Council Bluffs, Iowa

F.O.B. WRL

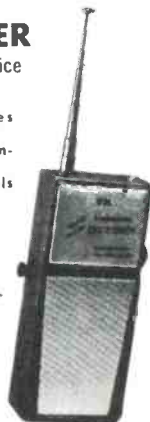





# ELECTRONICS 'N STUFF

by **DON STONER, 11W1507**  
 BOX 7388  
 ALTA LOMA, CALIF.

Jerry looked ashen white as he entered Sam Seebie's Service Saloon. He dropped into a chair with a thud which gave the impression he could not have made another three feet.

"What gives, Jerry, you look like the FCC chased you all the way here," Sam chuckled. "You're almost right, Sam—man, have I got troubles," young Jerry confided. Sam put down his soldering iron and aimed his most fatherly look in Jerry's direction. "Nothing could be that bad Jerry, you look lower than a channel two crystal working on channel one," Sam tried to reassure his visitor.

"Mom's pulled the plug on my CB operation, Sam. I've got a bad case of HFI," Jerry blurted, all in one breath. "Humm," Sam said professionally, "have you seen a doctor?" Jerry visibly didn't like Sam's attempt at humor. "This is no time to joke, Sam, I been wiped out, and by own flesh and blood.

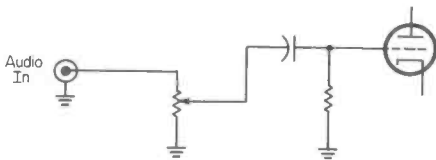

Fig. 1. Typical 1st audio stage found in an audio amplifier.

"My dad just got a new hi-fi set and we've been playing the TV set through it. The other day I called KEJ-4434 and creamed the sound portion of *'As the World Turns.'* Mom was madder than a 'wet hornet' 'cause she missed the best part. Now, I can't use my Osborne 300 until I have it fixed."

Jerry's verbal outpouring had captured Sam's attention. At the first opening in the

one sided conversation he hastened to reassure his friend. "First, Jerry, there is nothing wrong with your CB set, the fault is in that new hi-fi set your folks bought." A glimmer of hope spread across Jerry's face as Sam continued. "I can tell you what's wrong without even seeing the hi-fi.

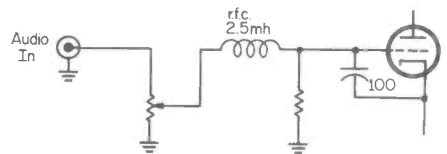

Fig. 2. Modifications to fig. 1 to prevent audio rectification.

The cable connecting the TV sound to the hi-fi set is probably long enough to pick up some of the radio frequency energy from your CB antenna. Look at this drawing on the blackboard (Figure 1) and you can see what causes it. The r.f. picked up on the cable is coupled to the grid of the first audio tube. To get the greatest gain, the manufacturer probably didn't put much bias on the stage. The negative r.f. cycles don't affect the stage, but positive peaks make the tube draw grid current. This produces the same effect as rectifying the signal which is there amplified by the following audio stages. For all practical purposes it has a built in crystal set in the front end."

By this time Jerry was considerably more cheerful. "I get it, Sam, but how can it be fixed without driving a hatched through that noise box?"

"No need for the rough stuff," Sam said as he erased the board. "Look at this modified circuit (Figure 2). If we stop the r.f. from getting to the grid of the tube we can

prevent rectification and interference from your rig. The values for the choke (r.f.c.) and capacitor (C1) are critical. If the choke or capacitor is too large, you will lose some of the high frequency sounds and the set won't be hi-fi anymore. However, in a radio or television set, where the sound is not quite so important, the choke could be replaced with a 47,000 ohm resistor and the capacitor could be increased in value to .001 mfd.

"Here's the characteristics of hi-fi 'i' or audio rectification, so you can recognize it when you have it. It can occur in phonographs, radios, television sets or intercoms, in fact any electronic device using an audio amplifier. Usually it doesn't matter what station you are listening to or what the volume control setting is. Your voice will come charging out of the speaker anytime the audio amplifier is on. To cure it, (1) locate the first audio stage. You can determine which stage this is by touching the grid with a screw-driver. The one which makes the loudest hum is the 1st audio stage.

"(2) Disconnect the grid coupling capacitor and connect a 2.5 millihenry choke in series with the capacitor lead.

"Cut the leads of a 100 mfd. capacitor short and connect the capacitor between grid and cathode of the 1st audio stage. This should cure the trouble. If there is still a trace of interference, you can increase the electrical size of the capacitor slightly. In radio and TV sets you can substitute the less expensive resistor for the choke, as mentioned earlier.

"Transistor audio amplifiers can be cured with the same technique. However, because of the lower impedance in transistor circuits, use a 3,900 ohm resistor and a 0.001 mfd. capacitor."

Sam was just finishing his tirade, when Jerry leaped from the chair and bolted for the door. "Hey, where are you going?" Sam yelled after his departing guest. "I've just got time to get our chassis out of the cabinet before Mom gets home." The door slammed behind him and Jerry disappeared around the corner grinning from ear to ear.



*This is the*

## **NUVISTAPLUG**

*The NUVISTAPLUG is a highly effective nuvistor amplifier designed as an exact replacement for the present rf amplifier tube in most communications receivers.*

*The NUVISTAPLUG will replace 7 pin miniature pentodes only. It will operate in almost 80% of all receivers using a 7 pin miniature pentode as the rf amplifier, reducing the noise level quite noticeably, and thus making weak signals pop out above the noise level.*

*The NUVISTAPLUG is sold on a money-back guarantee in the event that it doesn't improve your particular receiver. More than 2,000 Nuvistaplugs are currently in operation, and the manufacturing facilities have been stepped up heavily.*

*NUVISTAPLUGS are now available in large quantity for immediate delivery. Be certain to specify exactly which model is desired. Don't delay! Your receiver most likely will be greatly improved by adding a NUVISTAPLUG. You'll never know unless you try it.*

**ONLY \$17.95**

postpaid  
(No C.O.D.'s)

**RAYTRONICS**

Post Office Box 672  
Times Square Station  
New York 36, New York

N.Y.C. Residents add 4% City Sales Tax

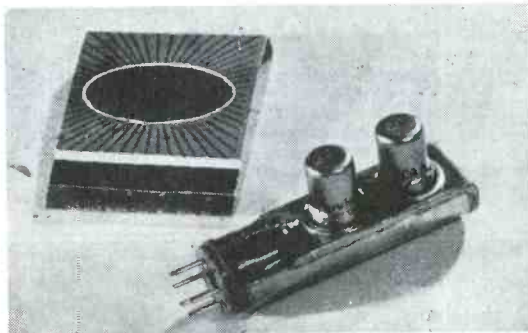

# CB CHIT-CHAT

**INDIVIDUALS AND CLUB MEMBERS!  
SEND US ITEMS FOR THIS COLUMN!**

**TO JOHN KREJC, 2W4586**

40 LANZA AVE.  
GARFIELD, N. J.



Leo Parsons, KC11684, of Kinston, North Carolina has found an interesting and attractive use for an obsolete radio cabinet in customizing his CB rig. On top of the cabinet is located his Hallicrafters Model CB-3A, a GC Signal Optimizer, an RCA Power Line Monitor, a Heathkit monitor Scope HO-10, and a Channel Master Beam Rotor. On the wall over the rig are a clock, barometer, and hooded light. His external crystals are embedded in a block of styrofoam for maximum protection and easy access. Within the cabinet are located a power light, phones and phone plug, antenna switch, booster toggle switch, speaker control, power control, AC voltage light and switch, DC voltage meter, calibration meter, modulation meter, DC milliamp meter, and range expander. The lower panel of the cabinet slides out exposing a large storage area for phones and charts. An active member of the Helping Hand Citizens Band Radio Club of Kinston, N. C., he has taken part in many of the public service activities of the organization.

**COMING EVENT**—The North Georgia CB Club of Dalton, Georgia will hold their CB Jamboree Saturday, August 31 and Sunday, Sept. 1st. Channels 11 and 21 will be monitored.

The Dixie 5 Watters CB Club boast a membership of 15. The club monitors channel 11 and in case of emergency the CB'ers in the area of Piedmont, Ala., have direct communication with the Police and Fire Dept., via channel 11. Thanks to Benny Bangs, 6Q4537.

**COMING EVENT**—The Tri-State 11 Meter Club will hold their annual picnic, August 4th, American Legion Grounds, Wintersville, Ohio, Route 22. 5 large CB goodies will be raffled. Monitor channel 9 and 11.

An S9 exclusive—Bill Nichols, 19Q0536, A.P.R.E. would like all clubs in the 19th area to send him their monitoring channels, addresses, meeting nights, etc. Bill's address is 338 Patterson Lane, Weirton, West Virginia.

The Tri-State 11 Meter Club of Weirton, West Va., and Steubenville, Ohio, worked in close cooperation with West Virginia's Hancock County Sheriff's office in providing communications and mobile escort for the 30 mile Centennial hike which was held in conjunction with President Kennedy's physical fitness program and West Virginia's Centennial-1863-1963-celebration.

Received the fine club paper of the Capital District Citizens Band Radio Club of Albany, N. Y. Editor is Isabella Sauer, KBI2478, co-editor, "Bobbie Aiken," 2A4918. Looks like the women are doing a terrific job!

**COMING EVENT**—Maumee Valley CB Radio Ass'n, Inc., will hold their Jamboree, Sept. 22nd, Hessen Cassel Recreation Center, Fort Wayne, Indiana. Good way to end a summer. Good luck to the group.

The Bear Valley CB Club at Big Bear Lake is getting ready for the summer trade. They were ready to help travelers during the winter season, but "Old Man Winter," didn't cooperate and provided the usual amount of snow. As a result, traffic was light. If you plan to travel in this area, be sure to have a channel 11 crystal in your rig. When in the low desert near Palm Springs, the latest info on wind and sand conditions can be had on channel 9. Jack Kinsey, 11Q5345 reports, that the boys down that way helped him drive safe and sound out of one of the worst sand storms of the season. Without CB and the cooperation of all CB'ers in the desert area, he could have been just another accident stranded at the side of the road. THANKS, from JACK.

There are 3 clubs in this area doing a fine job helping people when they need help. A special note of thanks should go to the Five Watt Wizards of San Bernardino Valley who started the whole thing in the area with their monitoring station, KEJ0922, Monitor channel 9. CB'ers in the San Bernardino, Big Bear Lake, and Palm Springs area really appreciates the fine work of these 3 clubs.

The Packerland Radio Club of Green Bay, Wisconsin, recently donated their services to a local telethon. Their main task was communications throughout the building, using several base stations. Many of the members used walkie-talkies. Publicity Chairman of the group is Jo Ann Neklewitz.

The newly formed Hall of Fame CB Radio club of Canton, Ohio recently elected Jerry Boswell, KHG2029, President. The club has a membership of 93, and invites all CB'ers in the Canton area to attend.

The Cannelton CB Club of Cannelton, Indiana was organized March 28th and has a membership of 19. The club meets the first Wednesday of each month in the Cannelton Youth Center. President of the group is James Bolin, KHC2356. The club monitors channel 9.

**COMING EVENT** The Third Annual Heart of Ohio CB Fiesta will be held August 11th from sun-up to sun-down. The event will take place at the Marion Fairgrounds located within the city limits of Marion, Ohio.

The Circuit Breakers, a new club that was formed in Richmond, California has a membership of 50. Members belonging come from five different counties in the bay area. Meetings are held on the first Thursday of each month at a local hall. The club is associated with the California CB Association, which is comprised of 24 clubs in Northern California. President of the club is C. L. McMonagle, KFD0278.

Another new CB paper, the GRIDLEAK, club paper of the Citizens Radiophone Ass'n of Detroit, Michigan. Editor of the paper is John, KHG6838. President of the club, Wayne Millen, 19Q8164.

The Five Watters of Lake County, held their annual banquet, May 25th, at the Champagne Room. A Smorgasbord dinner was served. The club has a membership of over 130 strong. Remember BOYS, renew your membership!

Mike Duffy, KDF0907, of Fresno, California, informs us that all CB'ers visiting San Joaquin Valley points, might make a record of the fact that 12Q3251, Hamp, monitors channels 9, 11, and 20 for emergency calls. From his vantage point in the mountains, Hamp can receive calls from just about any point in the valley and will make the proper contacts in any emergency.

The So. California 11 Meter League, Bell Gardens, California advises that they are now the proud sponsors of a Boy scout Troop. A very successful Radio Hunt was conducted by the group, recently, and it was won by Hy Paul, who declined the trophy in favor of the third place prize, of QSL cards. Cricket and Al Beck received the trophy for first place and second place went to Dick Klemm. Bill Yates, KEJ0615 who was appointed to fill the vacant office of treasurer for the 11 Meter League, entered the hospital on April 24th for a serious operation. Bill is now home again. We hope he has fully recovered and feeling his usual self.

FROM CANADA comes word of the Greater Niagara District Safety Rescue Association. The club boasts a membership of 54 and are a company of men who are dedicated to rescue operations. Communications officer of the group is Arthur Mitchell. Let's hear more from the Canadian clubs.

CB'ers help in recent storms in Hawaii. CB'ers in the town of Oahu helped in operations after a driving rainstorm hit the city suddenly. The CB'ers relayed messages, calling for help, and stood by on four channels to give any and all kinds of assistance. The group worked steadily from 4:00 until the water had cleared the streets and homes about 8:30 p.m. After the emergency had ended, one of the officials of the State Disaster Committee, came on the air with a personal note of thanks from the Director to all operators of CB for their splendid cooperation and their ceaseless devotion in time of emergency. Fine job, Bee, KIP0020.

REACTSHUN, club paper of the REACT of Orange County, California comes the news that Tex Hodnett, KED0202 is their new editor. Tex is in the U.S. Marine Corps, stationed at El Toro Marine Air Station, near Santa Ana, Calif. Ed Maust, KEJ0770, communications officer for this REACT Unit, advises that they monitor channel 3, 24 hours a day. There is always someone on CONTROL 3 at all times. The Unit is also making plans to monitor channels 9 and 11, part-time. The club recently held a mobile run to Big Bear, which was successful.

The South Georgia CB Club, held their CB Jamboree, May 19th at Jekyell Is., Ga. CB'ers within a 200 mile radius gathered to attend this gala event. Jamboree Chairman for this year was Mrs. Ann Whorton, KDD-2450, who did a wonderful job. A good time was had by all, meeting new friends, swapping cards, and feeding their faces.

At a recent meeting of the Tri County Emergency Communications Net, an honorary membership was presented to Frank "Pop" Colliton, of New Castle, N. H. as a result of the good will and community service he has rendered to other CB'ers and non-CB'ers alike. Hats off to Pop, from S9.

The El Camino Real CB Radio Club held a dinner-dance June 29th of which the door prize was a CB Transceiver. The club holds their monthly meetings the last Thursday at the VFW Hall, Azusa, Calif.

Gene Grant, KEJ6251 and Jim Stratton, KEJ0294, report the formation of an REACT Team in the Pico Rivera-Whittier-Montebello area. Donna Capp and Bill Capp recently celebrated the receipt of the licenses,



LITTLE JIMBO GOODMAN, son of Mr. and Mrs. Morris Goodman, who are members of the JACKSON CITIZENS BAND RADIO CLUB, INC. The sign is one of six that will be placed on the highways coming into Jackson which will serve as information for tourist and travelers who need help.

KFA2596 and KFA2587 at a open house for CB'ers in their local area. Bill is the proprietor of CAPPS BAR-B-QUE in Pico Rivera.

REACT of South Western Los Angeles County, supplied the communications set-up for the Armed Forces Day parade, in San Pedro. The operation was very successful and their help was truly appreciated by those in charge.

The club has ordered brilliant red wind breaker type of nylon jackets for all members of the team. The jackets are light but warm and great for use during the emergencies handled by the unit.

Recently the Jamestown, N. Y. area reported 2 small boys were lost, of which the Jamestown Police began a search immediately. 65 man Reserve Division was also called to assist. Frank Dustin, police reserve officer and President of the Chautauque County Citizens Band Club volunteered the services of the clubs mobile units. Within a short time over 50 CB equipped mobile units had entered the search. The Jamestown Police Reserve have been using CB Radio for several years. The 2 lost boys were found after 6 hours, sleeping, safe and sound.

The Otter Valley Citizens Radio Club is a little over a year old and still growing. The membership is approximately 76, and they have a fully trained rescue squad, all who are holders of Red Cross Training. The QRM is their monthly publication. The club also are members of the REACT program and are rapidly setting up service to travelers and vacationers in the Green Mountain State. President of the club is Charles Palluto, 1W3478.

COMING EVENT—The Tri-County Citizen "D" Banders Inc., serving north-central W. Va. is holding their annual CB Round-Up Sunday, August 11th at the Tygart Lake State Park, Grafton, W. Va.

The Elk River CB Club has been formed for CB'ers in the Clendenin-Elkview, West Virginia area. The club has a membership of 42 and meets twice monthly. President of the club, Ted Pennington, KH10613.

COMING EVENT—COWAN CB'ERS will hold their famous Fall CB Jamboree Round-Up Sunday, Sept. 15th at the Smith Auditorium, Memorial Park, New Castle, Ind. Starts 9 a.m. Rain or Shine. Monitor Channel 9. All kinds of CB displays.

Another new club—The C-Bee Squares, of the Greenville, Belding, Orleans, Sheridan, Gowen area compose



the club. So far the club has 20 members and meets every 3rd Monday night at the City Hall Club rooms. President—Don Schroll, KHG8348.

The Tri-Valley Radio Club of Thousand Oaks, Calif. reports its REACT program in full swing. Much credit for its success is due to Skip Renner, KEJ7264, aided by his new assistant, Fred Schrader, KEJ1784 and ably helped by Andy Miller, KEJ3841-U2. One of the big affairs each year is a three day celebration of Conejo Valley Days of which the club participated. The club was very proud of the float they entered. One of the valley club members found a wallet belonging to a Charles Hibbits of Camarillo. When it was returned an offer of a reward was refused. Mr. Hibbits was so appreciative that he mailed a donation to the club. The members wish to express their thanks to Mr. Hibbits.

News from E. H. Kligerman, KBA7404, President of the RAYTHEON CB HAWKS. Let's hear more. Sounds real good!

**COMING EVENT**—The Napa Valley Final Five CB Radio Club, of Napa, California, is holding their annual CB Round-Up, August 3rd and 4th, at Doran State Park, Bodega Bay, California. Look for a blast here!

January 8, 1963 the citizens band radio operators of Eastland, County met and organized the "Ten-Ten CB Club." The club now has 22 members and anyone holding a class D license may submit an application for membership. President of the club is Roy Smith, KEH-2030. The club motto is "Service on Standby," which corresponds with the name. The club members monitor channel 11, 24 hours a day. The club is associated with REACT.

Recently several members of the CEE Banders Club, Alabama, volunteered services of their radios and automobiles for transportation from the Bankhead Hotel to the Municipal Auditorium for the Annual Wheelchair Convention.

**COMING EVENT**—The Five Watter CB Club Inc., will hold their Jamboree, Sunday, June 30th at the 119th Armory, Lansing, Michigan. Channel 9 will be monitored for directions. 10 a.m. till ??

**COMING EVENT**—1st Annual Massachusetts State Jamboree, to be held Sunday, July 21, 1963 at the Conny Outing Grounds—Monnoth Rd., Dracont, Mass. The Jamboree is being sponsored by the The Five Watt Whips of Lowell, Mass. For mobile directions monitor Ch. 5-9 or 11.

**COMING EVENT**—For those who are interested in taking a trip in Maine this summer, the State of Maine Jamboree will be held August 4, 1963, at the St. Frances College on Pool Rd., Beddeford, Maine.

The Band-Spread, official monthly publication of the Tri-County Citizens Radio Association Club personality of the month was Fred Martin, 3W3881 who is a Charter Member and presently a member of their Board of Directors. Fred served as Chairman of the Board when the Club was formed in August, 1961 until elections the following February. He has been a very enthusiastic hard worker for the club and has attended most, if not all, special activities of the club.

**COMING EVENT**—Aug. 25th the Sociable 5 Watts Picnic will be held at No. 10 Route 51 Beaver Falls, Pa.

Newly elected officers of the Santa Clara County Citizens Radio League are: Pres. Dick Southern, 12Q-3113, Vice Pres., Del Crawford, 12Q0689, Sect'y, Vince Bertalacci, KFC0095, and Treas., Frank Volz, KFC2348.

Editor of the Minutemen Flash, Club paper of the CB Minutemen of Washington, Inc., Washington, is Ernie Tolman, KF10104. Clubs wishing to exchange club papers write: E. M. Tolman, 9042 208th N. E., Redmond, Washington. REACT Organization Chairman is Les Warriner, KFJ0268.

Recently the Lycopom CB Radio Club of Pa., rendered assistance to a state wide project called Sabin Oral Sunday. They were in operation from 12:00 noon until 6:30 p.m. with a grand total of 16 units plus their own club vehicle operating as control. The clubs part in the project was under the direction of Mr. Thomas Gerber, Chairman in charge of distribution. All participating members are to be complimented on the fine manner in which they conducted themselves. In a letter from Mr. Gerber, it was stated that words could not express their appreciation for the services that they rendered. The club has also come out with a very fine, good looking hand book, which is a roster of license holders in the area. President of the club is William M. Lyons, KIC0382.

Another successful social evening was enjoyed by the 10-99 Club of Orange County, recently. This club is earning quite an enviable reputation with their enjoy-

able social gatherings. Highlights of the evening were, dancing, community singing and of course, snacks.

About 25 CB'ers in the Pico Rivera Whittier area, gathered at the home of Rene and Wendell Spencer, KFA0101 and KEJ1576 respectively, recently, to wish John Kay, KEJ0812, Happy Birthday, Cousin John, or "Yak Yak" as he is known to his many CB friends, divulged that this was his 33rd birthday? Surprise visitors were Mike Duffy, KFD0907 and wife Betty from Fresno, California. Mike is a member of the Fresno CB Radio Club. Several Fresno club members attended a CB Jamboree, which was held at Cloud Five by the CB Club of Sunnyvale, California. Cloud Five is from Gilroy, California. President of the Fresno Club is Jim Rachel, 12W3826. Count down getting closer, R.M.F. From the Marion County Radio Club, Jefferson, Texas, comes the news that the club has helped in rescue operations of several drownings in the area. The unit has also been cooperative with the Marion County Civil Defense. Thanks for the news Gene, KEH0347.

The Little Rhode CB'ers, Prov., R. I., plan to have 5 members on 5 monitoring channels, with 4 or 5 mobiles. Now 2 units monitor day and night, with 4 and 6 hr. shifts, channels 11 and 15 at present.

Many CB'ers are saddened by the passing of their good friend Carl Swanson, KBC0735.

A new organization called—The Channel Wonders of Westerly, R. I., with president, Thomas Lambodi. The unit is building a mobile trailer for emergency work. The club is also setting-up a network, on channel 3. All members were contacted in 3 minutes during their first drill.

In the New Bedford, Mass., recently a request for mobiles were answered to help in a search for a 80 year old man who was lost in the woods.

Recently members of the CB "5" Watters of Virginia, local CB'ers and CB'ers from around the Tidewater area of Virginia and neighboring cities in North Carolina had a real successful Jamboree at Newmarket Shopping Center in Newport News, Va. The event was sponsored by the Newport News Civil Defense in cooperation with the CB "5" Watters.

Sunday, June 30th the CB "5" Watters held their annual picnic at Jamestown Beach at Jamestown, Va. All that attended had a very enjoyable time with boating and swimming in the atmosphere of their colonial ancestors. The grand prize was a Polycomm CB set. Any CB'ers desiring to join the club may do so by attending their monthly meeting at the American Legion on Warwick Blvd., the first Wednesday of each month. Good luck to the club and E. L. Brooks, KC10192.

The Clam-bake which was scheduled by the Norwalk Citizens Band Radio Assn., for September 1, 1963 has been canceled. The NCBRA holds their meeting at the East Norwalk Library, 51 Van Zant St., East Norwalk, Conn., and there is a standing open invitation to any CB'er to attend a meeting and say hello over a cup of coffee.

**COMING EVENT**—The Bergen County Citizen Banders Chapter of M.C.E.U. will hold their 3rd Annual CB Jamboree, Sept. 8th, at the Sundance Lodge, Caldwell, Twp., Route 46, Caldwell, N. J. This one should be even better than the one they held last year. Look for a REAL BLAST HERE.

**COMING EVENT**—The Hudson-Essex Chapter of the C.B.R.R.L. will hold their annual picnic, August 11, Valley Spring Lake, Route 23, Riverdale, N. J. Follow the signs. Let's all try to attend this one and have a ball.

From the "Signal News," club paper of the Radio-active CB Club, of Oak Ridge, Tenn. comes the news of a raging forest fire in the Lake City area of east Tennessee recently. The fire started noon, Saturday and continued until 3:00 p.m. Sunday afternoon, but thanks to efforts of a number of volunteers and local CB'ers much land and property were saved. A big help in the firefighters assistance was the use of CB Radio. Assisting were Jim Epperson, KDB2276-U6; T. J. Albert, KDB2675; David Bryand, KDB1914 and Don Cawood, KDB9485. The CB'ers stayed on the job until midnight Saturday and returned to the scene early Sunday morning. A big tip of the hat to these men and their contribution to their community and for a better CB Radio. Thanks to Bill, KDD0301.

The Citizens Band Assn. of South Alabama, Inc. completed another month of energized activities. The club installed scotch-lite signs on all main highways leading into the city limits of Mobile, Ala., announcing to transits that CBASA monitors channels 2 and 11. The annual social was held April 21st. The final stage

of polio immunization was executed in Mobile County, Ala. on May 1st and 2nd with CBASA furnishing communications.

The Giant Eyeball QSO, sponsored by the Norwalk CB Radio Club has been called off. The date was to be August 11th.

The Tri County Citizens Band Radio Club of Ill. held its monthly meeting and voted 12 new members into the club. Plans were formulated for the Club Patrol Group to police the grounds and control traffic for the coming Gyro Air Show. This presents quite a challenge to the control group, under the leadership of Vic White. The group will hold their picnic July 14th at the Illinois Beat Club Park, Erie, Ill. Several thousand people are expected to attend.

Happy birthday to the Montclare CB Club, who are 1 year old. The club has a membership of 180 and still growing. The officers of the club would like to express their appreciation to the membership and all those who donated their time in making their club, the model Club of Chicago.

Ron Palmer, KIC5747 and Bill Harms, KIC4374 spotted flames while mobile that looked like a garage on fire. After investigating they found it to be a large shed within 6 feet from the house. After trying to arouse the neighbors and getting no response they called to another net member to call the fire dept. and police. They started to fight the flames with garden hoses and had most of the fire out when the fire dept. arrived.

The W.N.Y.F.C.B. sponsored a dance on May 25th at the V.F.W. Hall in Lockport, N. Y. Elected King and Queen were Ron and Gail Otmanski, KIC2828, of Cheektowage, N. Y., who will represent the club at the V.F.W. parade in Lockport, June 2. The club was presented with the first place trophy for the float that they had entered in the parade. President of the club is Peter Russell, KIC1734.

**COMING EVENT**—The Delaware Valley Citizens League, Haddonfield, N. J. will hold their annual picnic August 4th at the Mullanheys Picnic Grove, Pemberton. How about it, let's all attend.

Well know look at this—Russell—better known thru-out the airwaves as "the voice of the rambling red-skin," KBG2874, 514 62nd St., West New York, N. J., recently introduced the first and only CB log sheet which took 9 months to create. He also has the only original bumper strip that is circulating around the country, made entirely with the CB'er in mind, and is also a safety measure for all cars. Russell is also known as one of the most controversial voices on the air. He was featured with "The Strange World Of Mr. Mum." Quite the guy. Could be a benefit to clubs to put this man on your mailing list . . .

The Hi-Desert CB Radio Club, now a member of REACT, held their first "Steak Fry," Saturday evening, June 1st, at Sheeps Pass Campgrounds, high in the mountains of Joshua Tree Monument. Delicious steaks, with all the trimmings, were enjoyed by almost the entire membership and their families. 16 visitors from the Pico Rivera area and 2 from Montclair made the trip to the Hi-Desert county to join in the festivities enjoy the hospitality of the desert club. Results proves that all the effort and hard work put into the arrangements for this outing by club members and all the officers were not wasted. Everyone that attended really had a "ball," the steaks were out of this world. Bob Forster, KEJ5806, one of the S9 A.P.R.E.'s, and his wife Kay were guests of the club.

On May 2nd, Miss Ellie Peek, KCF2474, Secretary of the Hub Citizens Band Club while in mobile, traveling south on Route 11 came in contact with a driver of a tractor and trailer which had run out of diesel fuel with no supply within miles and the hour being late at night. Ellie gave a call on Channel 1, but received no comeback. She then went to Ch. 9 and received a comeback from the REACT monitor, Fay Benedict in Hagerstown, Maryland and advised the monitor station of the trouble encountered by the truck driver. A check in Hagerstown via landline by Mrs. Benedict to the only Service Station open at this time of night, revealed that they had the needed diesel fuel, but they did not deliver. Mrs. Benedict and her son Eddie, KCF2574, left their base, went mobile to the service station, obtained the fuel and drove the distance of over 15 miles to where the driver of the tractor and trailer contemplated an overnight stay or a long walk in the dark. Our mikes off to all involved, this is going a long way out to benefit the distressed motorist.

REACT Radio Patrol has replaced The Hagerstown Unit of REACT effective June 8, 1963 under a reorganization plan and elimination of the former CB organiza-

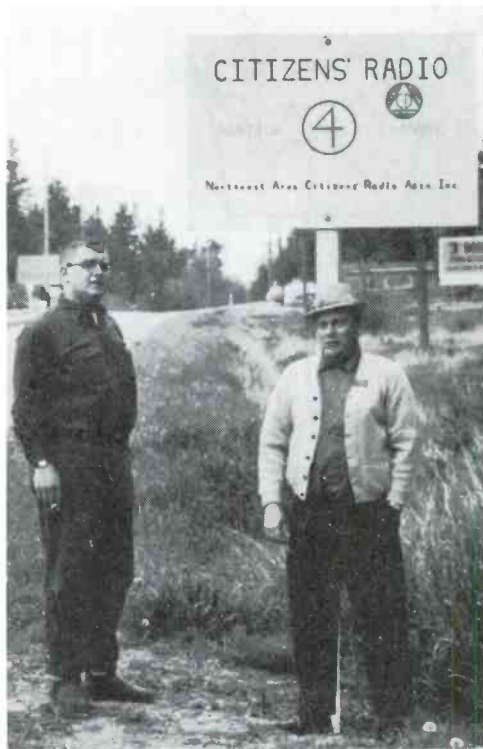

Pictured is the sign erected by the NORTHWEST AREA CITIZENS RADIO ASSOCIATION, INC., BELLINGHAM, WASHINGTON, for tourist and visitor information. The sign was erected on U.S. Highway 99 N, 1 mile south of Bellingham, Washington. Pictured from left to right—Jim Leverett, 14Q0959; Corporation-Trustee and Frank Cook, 14W2257; Association President. Photo courtesy of Ray Lundberg, KF10636.

tion in Hagerstown, Maryland. Directors Jim Cross, KCF0823, Bruce Campbell, 4W2480, and Ken Michael, KIC1265, are working on plans for a mock bank robbery, trying to locate a "getaway" car, working under the Maryland State Police roadblock plan. REACT Radio Patrol has been recognized by the Maryland State Police for use under their control anytime, with approval pending from the Hagerstown City Police and The Washington County Sheriff's Dept.

Members of the REACT Radio Patrol have been obtaining white short sleeve shirts and Director Jim Cross has been doing the honors by printing the familiar slanted REACT and mike in hand insignia on the back of the shirts with liquid embroidery. REACT Radio Patrol also has a Ladies Auxiliary, formed of members wives, mothers and girlfriends. The original meeting brought out 7 of the girls, who talked over the idea and voted to form this most welcome organization.

Information received from Bud Murry, KCF1954 of the Hancock Maryland-Needmore, Pa. area REACT team, reflects that they also have been recognized by the Maryland State Police and other organizations in their area. This team assisted during a very bad forest fire in Paw Paw, W. Va., received the gratitude of all concerned.

Also working in the Paw Paw area were members of the Mountaineer CB Club of Cumberland, Maryland along with their REACT members. They received a gratitude letter with gold key from the citizens committee. President Art Ashenfelter of the Mountaineer Club reports that Channel 9 is always open to the motorists in his area.

**S9**

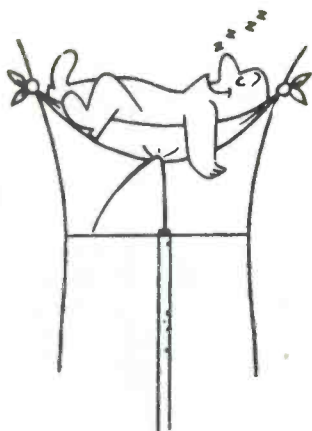

# ANTENNAS

by ED NOLL, KCC2618  
BOX 23  
CHALFONT, PA.

## PROPAGATION, A BIG QUESTION?

The average non-technical CB'er is inclined to expect too much from the improvements he makes in his system. The communications technician should always be aware of the "dream performance" that chases through the mind of a non-technical citizen bander. Doubling the power output from 1.8 to 3.6 watts does not mean that the range of transmission will be doubled. Doubling the radiated power by using an antenna with a gain of 6 db does not mean a doubling of your range. Doubling the antenna height does not double the transmitted range (unless in this step you can direct your signal over a specific obstacle in the transmission path). Doing all three things just mentioned does not mean that your transmitting range will be eight times greater or, for that matter, even doubled. Simple arithmetic simply does not apply.

An example will show the error of such performance fantasies. If we neglect all other possible factors that could attenuate a signal, a radio wave loses its strength rapidly with separation from the antenna because the energy is expanding outward from this single source. In fact, under this ideal and impractical situation the signal voltage (field intensity) declines directly with distance. At a certain distance from the transmitting antenna let us say that the signal strength is 100 microvolts. Therefore, at twice this distance the signal will have declined to 50 microvolts. Inasmuch as power varies as the square of the voltage, it means that the power output would have to be quadrupled to deliver 100 microvolts at the new distance.

In the above we have not considered the influence of the atmosphere, ground conditions, curvature of the earth, wave polarization, intervening obstacles, diffraction, refraction, reflection, multi-path signals, etc.

Improvements in a CB system can result in very important advantages in terms of reliability and noise reduction for a given operating range. These improvements should in no way be minimized. However, the subject of greater range should be soft-pedaled because of the difficulties encountered

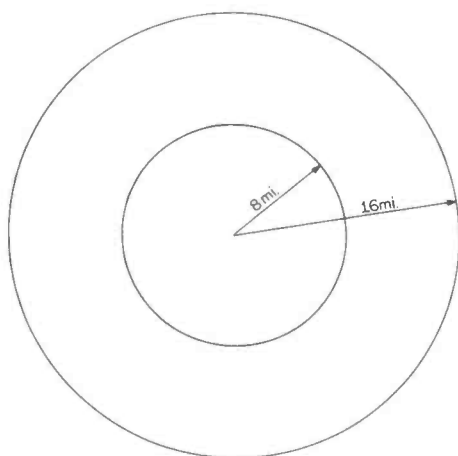

Fig. 1. Greater Range of transmission and reception also increases area of possible interference.

in extending *reliable range* and the questionable benefits of even desiring greater range.

As a matter of fact, the push for greater range of transmission in many areas has introduced new problems and has done little to solve some of those old problems it was supposed to have solved. Why this has happened can be understood very easily. Let us assume in a typical case, Fig. 1, the system operates well within an eight mile radius. A radius of eight miles corresponds to an area of about 200 square miles. Let us assume the station density within this area is about 100 stations per 200 square miles. In some areas there are fewer than this; in many areas, a higher density exists. Now we will go all out with equipment and accessories to double the transmission range to sixteen miles. Now the area covered corresponds to approximately 800 square miles. As shown in Fig. 1 this is a considerably larger area. If we assume the same station



density there are now 400 stations licensed within the new area.

What happens when all the stations within the area take the necessary steps to increase their ranges. Although we have extended our possible range we can now cause interference to or encounter interference from approximately four times as many stations. In areas of very high density it may well be that we have even cut down on the "always-reliable" range of transmission.

Frankly, the low power and low antenna restrictions of the FCC are blessings in disguise in terms of the services for which citizens band radio has been conceived.

#### POWER OUTPUT?

Transmitters with adjustable power outputs would be a great boon in the reduction of interference on crowded CB channels. Transmitters could be manufactured with a choice of at least two and perhaps three or four different output levels. Power levels of 1/2-watt, 2 watts, and 5 watts might be appropriate. For your own information, listen in on the CB channels and note how many contacts occur between stations within three miles of each other. In this restricted range one-half watt does as well as five watts under most circumstances.

The advantage of having a low-power transmit facility was brought out clearly by a local situation several weeks ago. A mobile station was operating with poor receiver sensitivity. Within three miles of the base station he came on the air thinking the channel unoccupied. Good contact was established. Unknown to the mobile operator, however, the channel was being used. In fact, he was later informed that he was interfering with two stations using the channel about twelve miles away. Here is a case where two communications could have gone on simultaneously without any interference if the two stations that were near to each other had been operating on low power.

#### PROPAGATED WAVES

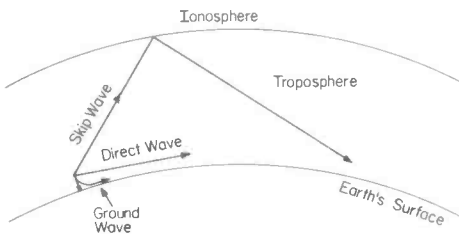

Fig. 2. Types of propagated waves.

In radio transmission, as shown in Fig. 2, there are three major types of propagated waves. One wave is the ground wave which hugs the earth and, as it travels, its energy is used up in ground currents. On the citizens-band frequencies this ground wave

## "NOW HEAR THIS . . . !" TOROID-TENNA

is the result of two years of intensive research and development for the most perfect CB transceiver antenna ever made to military specifications.

Others say they've done it, but we'll guarantee TOROID-TENNA has the lowest SWR and closest match ever achieved! This stainless steel, tapered antenna is just 42 inches long and features a tunable toroid transformer in its chrome-plated "heart" for a steady 1:1 SWR thus providing an easy 1/2 to 3/4 watt increase in output power. The toroid transformer is completely shielded from co-ax to whip. You don't have to "clip the tip" for your SWR—just tune it in a minute with a screwdriver for the finest, most powerful transceiving you've ever experienced. All its power is in the whip—not the base! (Also available for 6 meters.)

Special,  
chrome-plated  
universal  
mounting  
bracket for  
gutter, trunk  
or roof  
installation \$5.95

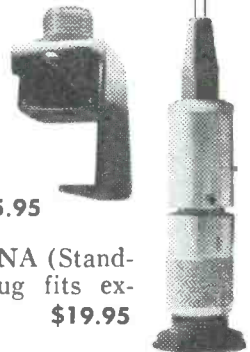

TOROID-TENNA (Standard PL-259 plug fits existing mounts) \$19.95

### ELECTRO-WINDERS CO. INC.

PR ANTENNA SYSTEMS  
854 WEST FRONT STREET  
COVINA, CALIFORNIA

ELECTRO-WINDERS CO., INC.;  
PR Antenna Systems Division  
854 West Front Street, Covina, California

Enclosed is my check (money order) for \$19.95 for a TOROID-TENNA. (Add \$5.95 for base mount.)

Name \_\_\_\_\_

Address \_\_\_\_\_

City \_\_\_\_\_ State \_\_\_\_\_

(California add 4% sales tax)



declines to an unusable level just a few miles from the transmitter.

Another type of wave is ionospheric. It leaves the transmitting antenna in a skyward direction. If conditions are right this wave will be reflected from the ionized layers many miles above the earth's surface. It will then return to the earth at hundreds and even thousands of miles away from the transmitter. This is what CB'ers call skip reception. Communications between skip stations is illegal on the citizens band. It should be added that the high background noise level and interference from skip propagation would be magnified with increased transmitter powers and higher antennas. Here we have another condition that favors low power and low antenna height in terms of the legal citizens band services.

Citizens band communications are almost entirely established over a direct path. This is a straight-line direct path between the two stations. It is sometimes referred to as a line-of-sight transmission path.

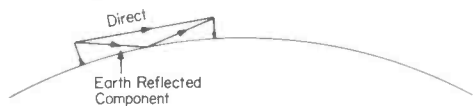

Fig. 3. Direct and reflected waves.

Sometimes this transmission path has a secondary component. This is referred to as a ground-reflected wave, Fig. 3. It is a component of signal that strikes the earth's surface and bounces back into the same path as the direct wave. The ground reflected component can either add to or subtract from the direct wave depending on the phase relationship between these two signals.

In most CB applications the ground reflected component is usually a good bit weaker than the true direct wave. Its effect is more pronounced when the transmission path is over a large body of water or over a flat terrain of good conduction.

### LINE-OF-SIGHT

High-frequency radio waves travel in almost a straight line, similar to a beam of light. Thus if

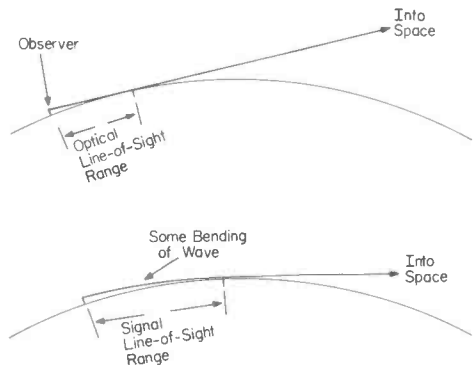

Fig. 4. Optical and signal line-of-sight ranges.

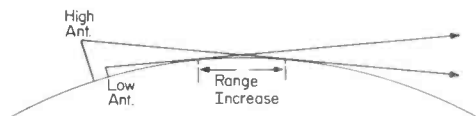

Fig. 5. Influence of antenna height.

there were absolutely no bending of the wave the range of transmission would be determined by the optical line-of-sight path. Thus the range of transmission would be only over the path for which the transmitting and receiving antenna would be within sighting distance. Transmit range would be to the optical horizon.

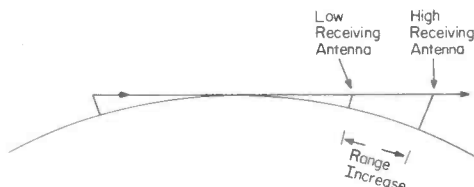

Fig. 6. Influence of Receiving antenna height.

Fortunately there is some bending of the wave by the atmosphere (troposphere) as in Fig. 4. Hence the radio wave hugs the surface to a certain degree and bends with it beyond the optical horizon. How much the signal travels beyond the horizon depends on range of transmission. When tropospheric variables have an abnormal influence on wave bending, signals are strong over a very extended range and communications can be held over substantial distances beyond the horizon.

Over many years propagation conditions have been measured and an average range of transmission has been established. This range of transmission is referred to as the *signal line-of-sight path* as opposed to strictly optical line-of-sight. Antenna height also influences the absolute range, Figs. 5 and 6.

$$\text{Range Miles} = \sqrt{2H_1} + \sqrt{2H_2}$$

$H_1$  = antenna height in feet of one antenna  
 $H_2$  = antenna height in feet of second antenna  
 Both 20 feet:  
 $\text{Range} = \sqrt{2 \times 20} + \sqrt{2 \times 20} = 12.64$  Miles  
 Reduction of one antenna to 10 feet:  
 $\text{Range} = \sqrt{2 \times 20} + \sqrt{2 \times 10} = 10.79$  Miles  
 Both 10 feet:  
 $\text{Range} = \sqrt{2 \times 10} + \sqrt{2 \times 10} = 8.94$  Miles

The first example shows the maximum condition when using antennas at a height of twenty feet at both locations. The signal line-of-sight path is approximately 12½ miles. Reducing one of the antennas to a height of 10 feet cuts back the path length by less than two miles. This proves that doubling the antenna height does not double the range of transmission, assuming no intervening obstacles. In fact, the path is still nine miles when *both antennas* are brought down to 10 feet.

The above figures are at the most just an estimate

*Continued on page 51*



# WASHINGTON OUTLOOK

by EDWIN FREDERICK, 2W4580

Here are this month's FCC actions against CB'ers:

2A5949, James Edward Feyko, Middle Village, N. Y., license revoked for repeated violations of Sections 1.76 of the rules and 308(b) of the Communications Act. Revocation became effective July 1.

2Q3700, Peter Hajzer, doing business as Main Auto Wreckers, Avel, N. J., license revoked for repeated failure to respond to official notices concerning alleged violation of rules Section 19.25(c). Revocation became effective June 26.

7Q0919, George Melvin Beane, Miami, Fla., license revoked for repeated failure to respond to official notices concerning alleged violation of rules Section 19.61(a) and (c); effective July 1.

8W2022, Billy R. Sherrill, Conway, Ark., given notice to show cause why his license should not be revoked for repeated failure to respond to official notices concerning alleged violation of rules Sections 19.17 and 19.92 and Section 310(b) of the Communications Act.

9Q1515, James C. S. Daus, Hot Springs, Ark., directed to show cause why his license should not be revoked for repeated violations of Section 308(b) of the Communications Act and Section 1.76 of the rules.

9W1371, Martin Doss, Jr., Pasadena, Texas, was asked to show cause why his CB license should not be revoked for repeated failure to respond to official notices concerning alleged violations of rules Section 19.33; effective June 15.

10W3878, Rosemary E. Thompson, El Paso, Texas, asked to show cause why her license should not be revoked. Reason not available at press time.

11Q1170, Gart D. Aston, Hollywood,

Calif., license revoked for repeated failure to respond to official notices concerning alleged violation of rules 19.61(a) and (c); effective July 1.

11W6140, Donald B. Morse, Anaheim, Calif., asked to show cause why his license should not be revoked for repeated failure to respond to official notices concerning alleged violation of rules Section 19.33.

19A5837, Leonard W. Mountford, Grosse Pointe, Mich., asked to show cause why his CB license should not be revoked for repeated violations of Section 1.76 of the rules and Section 308(b) of the Communications Act.

19A7927, Marko Yerkovich, Detroit, Mich., had his license revoked for repeated failure to respond to official notices concerning alleged violation of rules Section 19.25(c); effective June 26.

20Q1133, Walter T. Chick, Sr., Auburn, N. Y., asked to show cause why his CB license should not be revoked for repeated failure to respond to official notices concerning alleged violations of Section 19.61(a) of the rules.

KDB3578, Howard Wilbert Sweat, Dallas, Ga., was imposed with a \$100 forfeiture by the FCC for repeated and/or willful violations of Section 19.61(a) for unauthorized communications. The FCC notice went to him on May 8th; he was given 30 days in which to respond.

KDB7250, Thomas W. Clements, East Point, Ga., asked to show cause why his license should not be revoked for repeated failure to respond to official notices concerning alleged violations of Section 19.61(a) of the rules.

KDD0770, Donald F. Hester, Jr., Mableton, Ga., was imposed a forfeiture totalling

\$200 for repeated and/or willful violations of rule Sections 19.61(a). He was given 30 days from May 9 to respond.

KEG0878, Don M. Carpenter, Amarillo, Tex., license revoked for repeated failure to respond to official notices concerning alleged violation of rules Section 19.33; effective July 1.

KEG1808, Monte Rey Ariola, Santa Ana, Calif., license revoked for repeated failure to respond to official notices concerning rules Section 19.33; effective July 17.

KEJ1382, Electro-Mech. Engr. Spec. Co., Huntington Beach, Calif., directed to show cause why its license should not be revoked for repeated failure to respond to official notices concerning alleged violation of rules Section 19.33.

KEJ1482, Edward W. Owens, Prescott, Ariz., license revoked for repeated failure to respond to official notices concerning alleged violation of rules Section 19.33; effective July 15.

KEJ2825, Edwin J. Squire, Jr., Long Beach, Calif., asked to show cause why his license should not be revoked for repeated failure to respond to official notices concern-

ing alleged violation of Section 19.61(a) and (c) of the rules.

In the April issue we ran a letter in "Reader Mail" from Grace R. Langlotz, Editor of "The Groundplane" of the Virginia State CB Radio Assn. Grace asked if the FCC had any "official" right to monitor CB transmissions, in view of the Secrecy of Communications Section (#605) of the Communications Act. At that time we frankly admitted that we, ourselves, didn't know the answer to that one.

Shortly after the issue appeared, Mr. Ivan H. Loucks, the FCC's on-the-ball Chief of the Amateur and CB Division in Washington contacted us. Mr. Loucks supplied us with a document entitled "Docket 14579," which is the decision of the Review Board in the Commission's hearing with Warren J. Currence, whose license, 4W0152, was revoked by the Commission.

Currence's defense in the hearing was based upon his contention that the FCC had no right to invade his privacy of communications by monitoring his transmissions. The Commission, at that time, stated that transmissions which, in themselves, are in violation of FCC rules and regulations do not come under Section 605 of the Communications Act. The FCC further said that "Interception (monitoring) and divulgence (testimony) of radio communications by Commission employees for purposes of enforcement of the Communications Act are necessarily permissible and do not contravene the provisions of Section 605."

Many readers have expressed alarm after reading our July editorial about the forthcoming CB license fees. Apparently some radio people cornered their Congressman and talked him into introducing a bill, HR 6697, in the Committee on Interstate and Foreign Commerce which, if passed, would prohibit the FCC from imposing any fees whatsoever. The Citizens Radiophone Association of Detroit, Mich., for one, is promoting a "write your Congressman" campaign telling them of their opinions and feelings about the fees and urging support of HR 6697, which was introduced by Rep. Walter G. Rogers of Texas.

## A NEW NAME... for a "grand old company"

### MULTI-PRODUCTS COMPANY

OAK PARK, MICHIGAN

*Manufacturers of*

### QUALITY ELECTRONICS

*Since 1947*

### present the same fine products:

- designed for flexibility
- engineered for performance
- manufactured with precision

### under the new revised name

### MULTI-ELMAC COMPANY

Look for the  
Multi-Elmac Emblem  
Your Assurance of Quality



### MULTI-ELMAC COMPANY

21470 COOLIDGE HIGHWAY  
OAK PARK 37, MICHIGAN

FLASH! As we go to press we have completed the processing of the first group of QSL Swappers Awards. First in line was 59'er Dan Guthrie, KDB1435, of Spruce Pine, N. C. Dan took back to the shack the following awards: SACA, MSA, PX-100, and SSC-2. Congrats!

## TUBE SUBSTITUTION

*Continued from page 19*

although many of the "four digit" types are popping up on the military surplus market at budget prices.

Tubes shown with a #-sign before their number are "Nuvistaplugs." These are complete plug-in units circuits which consist of 2 Nuvistors in a cascode amplifier circuit. They are for replacement in the "front end" of the receiver section of a transceiver.

Tubes *not* indicated by parentheses or bold face type are "average" good replacements for the original types. They should approximate the original tube's performance, but it would be best to replace them with the original types when convenient.

You will notice that some tubes have designations such as ECC81, EL84, X155, etc., etc. These are foreign types which are popular in Hi-Fi equipment in this country. In many cases they are excellent permanent replacements for tubes in the audio or modulation sections of a CB rig.

Some tubes, you will notice, are not listed here. This is because there just aren't replacements for each and every single type of tube. If you have a CB rig which contains the following, it is suggested that you keep a spare around the shack: 6AN8, 6FM8, 12BW4, 6AZ6, 6AZ8, 6BJ7, 6EM5, 6CL8, 5763, 6BH7, 12AB5, and 6EQ7. There are others too, naturally. We suggest that you dig out your rig's instruction manual and see what you've got.

You might find it handy to list the replacements for all of your rig's tubes right on the inside cover of the instruction manual. This will save you the exasperating experience of trying to find this issue of S9 when you need it (we understand that some despicable people borrow S9's and "forget" to return them).

Do not attempt "reverse" substitutions. That is, replacing dead tubes shown in the right hand column on our chart with tubes shown in the left hand column.

Editor's note. The information contained in this article was compiled from material supplied by tube manufacturers. S9 Magazine presumes that this information is correct, but does not guarantee the degree of results which will be obtained by the application of the information. It must be remembered that slight electrical and mechanical differences may exist between the "original" tubes and the suggested substitutions.

**S9 IS FOR SPECIAL PEOPLE ONLY!**

Become someone "special," subscribe to S9, NOW!

## ANTENNAS

*Continued from page 48*

and assume a smooth flat terrain and an average amount of atmospheric bending. Of course, terrain conditions and obstacles make each location a specific one. The above figures, as just mentioned, are related to flat terrain. If your average terrain is several hundred feet above your local surroundings you can expect an even greater range of transmission. On occasion, more often at night, atmospheric bending is very pronounced and transmission paths of fifty miles or greater do occur.

The estimates do point out the influence of antenna height on the range of transmission. Furthermore they indicate that with a minimum of equipment, reliable communications should be possible at least over the calculated range. With gain antennas, low-noise receivers, and a good location reliable results can be obtained beyond this figure. Under most circumstances, reliable results beyond twenty-five to thirty miles is hard to come by even under idealized conditions.

### INTERVENING OBSTACLES

In metropolitan areas the influences of tall buildings, long bridges, and other large metallic surfaces are quite decided. Weak and strong signal locations develop at random because of reflections and the arrival of more than one signal at a given location.

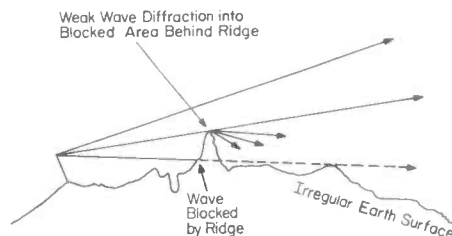

Fig. 7. Wave Diffraction.

There is some diffraction of radio waves over and around obstacles. Fig. 7 is an example of mountain-top diffraction. It might at first be expected that a high intervening hill would result in a complete black-out of communications at its rear. However, when a signal passes over a ridge there is some additional bending of the wavefront which causes it to dip down on the other side. Although the signal is reduced in its strength it is never the less present, usually at a useful level if within the signal line-of-sight range. **S9**

**BACK ISSUES OF S9**

**We've got 'em for you.  
Which do you need—  
They are 50¢ each.**



## CARD SWAPPERS

*Continued from page 37*

KIC0292 Bob Ramage, 445 Peebles, Pittsburgh 21, Pa.  
KIC0655 David Aunkst, 504 Todd, Pittsburgh 21, Pa.  
KIC1381 Tom Gutherie, R.D. 2, Butler, Pa.  
KIC1644 Jim Todd, Rd. #1, Saratoga Lake, Saratoga Spgs., N.Y.  
KIC2064 Gene Christy, 176 Chicora, Butler, Pa.  
KIC2553 Thurston Fleming, 327 Parsells, Rochester, N.Y.  
KIC2600 Jesse Aites, Jr., R.D. 2, Franklin, Pa.  
KIC2881 Mike Ripski, 72 Mooney Rd., Plymouth, Pa.  
KIC2911 Alan Walker Jr., 17 W. Green, Johnstown, N.Y.  
KIC3501 Phil Rodon, 16 Garfield Ave., Batavia, N.Y.  
KIC3644 Bob Dykeman, 10 Butternut, Lyons, N.Y.  
KIC4126 George Gruber, 172 Joseph, Horseheads, N.Y.  
KIC4514 Dick Kurcoba, 508 Gaines, Elmira, N.Y.  
KIC4570 Jim Walker, 2210 Jun. Gap Rd., Altoona, Pa.  
KIC4696 Jimmy Hall, 995 Ave. D., Rochester 21, N.Y.  
KIC4700 George Duncan, 23 Root, Butler, Pa.  
KIC5099 Edward Abounader, 1415 Oriskany, Utica, N.Y.  
KIC5174 Harrell Cook, 8 Colwell, Addison, N.Y.  
KIC6895 Paul Rogers Jr., 233 Freeland, Pittsburgh, Pa.  
KID0573 Chuck Hiles, 108 Westwood Mamor, Butler, Pa.  
KID0918 Robert Allen, 46 Jackson, Attica, N.Y.  
KID1299 Ed Barkowski, 1911 Freeport Rd., Arnold, Pa.  
KID1328 Ron Conley, 45 Murray, Rochester 6, N.Y.  
KID1361 David Lyon, Wellsboro RD 3, Pa.  
KID2196 Fritz Nowak, 80 Fairfield Ave., Lancaster, N.Y.  
KID2709 Harold Kilmer, Brocton, N.Y.  
KID2897 Stel Barkowski, 1911 Freeport Rd., Arnold, Pa.  
KID3134 Tony Febbo, 1635 20th Ave, Altoona, Pa.  
KID3167 Gordon Wood, 168 Main, Wellsburg, N.Y.  
KID3208 Roy Smith, Box 82, Scotsburg, N.Y.  
KID3233 Charles Andreen, 243 Climax, Pittsburgh 10, Pa.  
XM34212 Harris Walsh, Saskatoon, Sask. Canada  
XMI1947 Ron Bartsch, Box 329, Abbotsford, B.C.  
XM4363 Tom Newton 2093 Harvey, Niagara Falls, Canada

## READER MAIL

*Continued from page 4*

Outside the New York City area I have never heard stations on channels 3, 13, 16, 17, 19, 21 and 23. Why not some organized procedures to use all channels?

Carl Graham, KH11726  
Fairborn, Ohio

*The nationwide calling channel bit has been suggested to CB'ers so much that everyone here is blue in the face with it. It's a great idea but it does not seem that there will ever be any nationwide selection of a channel which everyone will stick with unless the FCC makes it gospel. At the present time there is a suggestion from S9 at the FCC which would establish a national calling channel in Part 19. We have also proposed specific uses for all of the other channels to obtain maximum sensible use from them on a national scale.*

### 10 CODES

Sirs:

I have a list of the "10 Codes" but recently I have heard CB'ers using codes which aren't on my list. Where can I obtain a complete list?

W. E. Herrick, KGH2989  
Emporia, Kansas

*The 10 Codes were devised originally by the Associated Police Communications Officers (APCO) for use over police radio stations. As a result, most of the official APCO meanings are highly specialized police messages not applicable to CB. CB'ers changed most of the original meanings and substituted their own. Some of the original ones remained, like 10-4 and 10-20, but most are different. Therefore, there isn't any "official" CB 10 Code and you'll hear different meanings for the same 10 Code number in various areas.*

**S9**

## KBG4303 RIDES AGAIN

*Continued from page 7*

rather than numerous billowing generalities—because the facts, when stripped of ACBA's candy coating, paint a rather bleak picture of an angry and sour organization (as proven by the tone of the telegram we received).

The ACBA apparently missed the fact that in the editorial we did *not* tell the readers to abstain from joining ACBA, we simply suggested that you, the readers, carefully examine the clubs which you join and the causes which you back. If the ACBA cannot stand this careful examination by prospective members then they should silently fold their tent and slip off into the night. Subsequent to the appearance of the editorial, we learned privately from a source within the ACBA that CB'ers have apparently taken up the suggestion to look at the facts and have not joined ACBA in the great swarms originally predicted; rather they have shown an alarming disinterest in the group.

If, as the ACBA states, our opinions are the result of the fact that we "do not know enough about ACBA," then it is the fault of the people who are writing the material for ACBA. There was no misleading information in the June S9 editorial and, in fact, the ACBA's telegram even contradicts some of its own pitches of only a few months ago.

For example, the author of the telegram states, "I am not an ambassador to Washington. I have no intention of being one." He apparently didn't read April's page 32 of CB Horizons, the club's "parent magazine." At that time it was stated, "... Walker and his Committee intended to soften up the FCC and Congress with a series of in person meetings."

Next, they tell us that they are not an "anti-FCC" club. Here are some more quotes: "The time has come for the people to stand on their feet and fight the FCC . . .", "The hotter we make it for the Commission . . ." " . . . the entire Commission is on the SPOT." "It appears that the FCC Commissioners may fall apart at the seams." "The Commissioners are in for a cleaning. Another week they will be fighting each other." "Why is one Commissioner passing the buck to the six other Commissioners?" These quotes are from the ACBA parent publication and from the pen of the ACBA's Executive Secretary. If these, and other similar, quotes don't spell "anti-FCC," we don't know what does!

So, as mentioned previously, if there is a misunderstanding as to the intent of the ACBA it is the fault of the people who are writing the material. This poorly-stated material should be rewritten in somewhat different terms if the originally issued state-

ments were incorrect. Many of the ACBA's references to personnel at the FCC are, in our opinion, without any basis in fact, are in very bad taste, and are not in the best interests of the Citizens Radio Service.

Until the ACBA brought up the subject of a feud with another publication we didn't know that one existed. On the contrary, we have always felt that our relationships with other publications were most cordial. As an example of this I would point out that on May 17th last I was invited out socially by Bob Cooper, Publisher of CB Horizons. This is the same publication with which the ACBA seems to think we are having a feud!

Subsequent to this, on May 22nd, while I was in Chicago, I was sought out by a staff member of a CB publication who implored me to give editorial backing to ACBA in S9's pages. Since my answer to this person bears upon the above telegram, I'll relate it here.

I told him that S9 has no axes to grind with anyone and that we have always supported "national clubs" when they were worthwhile. I went on to say that until now, the ACBA has done more harm than good; that should the group ever reach an acceptable level, we would most certainly give full consideration to supporting it. Until then, I told him, we will criticize it if, when, and where necessary, regardless of the fact that we are probably inviting ourselves all manner of shabby lampoon from ACBA and friends.

So we don't see a feud here, although we can speak only for S9. If there are other publications which feel that they have a feud going with S9 we wouldn't know about it nor would we want to be involved in such a childish business.

The ACBA's invitation for me to appear in a public debate was most flattering, especially in view of the fact that they just finished telling me that I didn't know what I was talking about. Be that as it may, I must confess that I am but a humble observer and reporter of the CB scene. I am not, by any means, the leader of the "loyal opposition" nor am I an elocutionist wishing to exchange assorted vilifications and hot air with the ACBA for the purposes of lending S9's name to their efforts in filling the hall at their get-together.

I have always regarded a debate as two or more people trying to change each other's way of thinking. In such a situation I'm afraid that I wouldn't have been much in the way of providing an entertaining evening anyway, because we at S9 will never be able to accept the *present* thinking and tactics of the ACBA. If the purpose of the debate was to clarify each of our positions, I am certain that no clarification was needed as it already exists.

S9 therefore has joined the rapidly growing list of potential debate opponents (which includes Senator Kefauver and the 7 FCC Commissioners) who have declined being associated with the ACBA at a meeting. We did this with the full expectation that the ACBA will most likely try to capitalize upon this decision by means of casting aspersions, since this was done the others who declined the same invitation.

If the ACBA is genuinely interested in knowing how we at S9 feel about the status of their life and times, we suggest that they read our opinions in the pages of S9 each month. Club subscription rates are most reasonable.

In closing, we would like to state that it is sincerely hoped that the ACBA gets on the ball and stops the rabble rousing stunts, the vicious personal attacks being made upon personnel at the FCC, the participation in promoting illegal "skip," etc. We shall be sitting on the sidelines with the S9 readers. The ACBA may expect comments (pro or con) as our readers and conscience dictate. No one, including the ACBA, can intimidate S9 into taking a stand to endorse something which we honestly feel is innately wrong and not in the best interests of the Citizens Radio Service.

**S9**

## ON THE COUNTERS

*Continued from page 32*



The Frequency Synthesizer is an accessory for the 100A. It permits combined selection of both receive and transmit on all 23 channels, thereby eliminating the need to change receive or transmit crystals. Nothing much can be said about the unit other than it's well made and does the job it's supposed to do. The Synthesizer is connected into the EXEC in a matter of minutes, the instruction manual and a soldering gun are the only aids required. While the price of the unit may, at first, appear high (\$159.50) it is reasonable when you consider the cost of buying 46 crystals.

**S9**



# advertisers index

Amateur Electronic Supply .....	22, 23
Antenna Specialists Co. ....	5
Browning Laboratories .....	8
Cadre .....	14
e.c.i. electronics communications, inc. ....	Cover 3
Electro Winders .....	47
G. C. Electronics .....	32
Garth Printing .....	37
General Radiotelephone Corp. ....	Cover 4
Grove Electronics .....	32
Hammarlund .....	11
Heath Co. ....	6
Hy-Gain Antenna Products .....	28, 29
International Crystal Mfg. Co. ....	Cover 2, 1
E. F. Johnson Co. ....	26
Lafayette Radio .....	56
Lew Bonn .....	35
Mosley .....	24
Multi-Elmac Co. ....	50
New Products .....	39
Part 15 Identifier .....	34
Petersen Radio .....	31
RCA .....	3
Raytronics .....	41
S9 Subscriptions .....	17, 30
Texas Crystals .....	13
Turner Microphones .....	31
World Radio Labs .....	39

## CB SHOP

Rates for CB SHOP are 10¢ per word for advertising which, in our opinion, is obviously of a non-commercial nature. A charge of 25¢ per word is made to all commercial advertisers or business organizations. A 5% discount is in effect for an advance insertion order for six consecutive months.

We do not bill for advertising in CB SHOP. Full remittance must accompany all orders and orders sent in otherwise will not be run or acknowledged.

Closing date is the 15th of the 2nd month preceding date of publication.

We reserve the right to reject advertising which we feel is not suitable.

Because the advertisers and equipment contained in the CB SHOP have not been investigated, the publishers of S9 cannot vouch for the merchandise or services listed therein.

**IF YOU'RE LOOKING TO SAVE MONEY ON QSL'S LOOK ANYWHERE ON THIS PAGE— IF YOU WANT THE FINEST QSL'S AVAILABLE, SEND 15¢ TO THE MAD ART DIRECTOR/KBG7126/5009 Broadway, N. Y. C.**

**QSL CARDS, EYEBALL CARDS.** The latest designs, colors, cardstock. **FREE SAMPLES.** APRIL SIGN 56290 Van Dyke, Washington, Mich.

**CBers**—As described in feature article of March S9; Speech clipper-kit complete \$17.85. Also, our famous Dual Conversion easy-do adapter-kit, improves selectivity, increases sensitivity. For HE-15, A, B, 800, 910, B, etc. HE-20, A, B, C; Mark VII. 770, 1, 2. Messenger. GW-10, etc. All parts, schematic, pictorial complete; \$15.50, with tubes \$17.50, or \$5.00 deposit plus C.O.D. Order now! Free literature Dept. "6S". Bainbridge Radio Electronics, 2839 Briggs Ave., New York 58, N. Y., or your local dealer.

**QSL Cards, 100 two color Glossy, \$2.50, postpaid. Samples dime.** Ramsbottom Printing, Box 2373, Kirksville, Missouri.

**WALKIE-TALKIE RADIOS: CITIZEN BAND EQUIP.; INTERCOMS; RADIO-TV PARTS—FREE CATALOGUE—ALLEN ELECTRONICS, 4142A Main, Flushing 55, N. Y.**

**QUESTION**—Want to design a QSL card? Sampler Instruction Kit 25¢ Wow! What cards you can create. \$1.50 and up 100 Samco Box 203, Wyncottskill, N. Y.

**CB QSL's, 100 for \$3.00, samples 25¢, Redbird Printers, Freedom, Indiana.**

**1000 personalized gummed name and address labels 2" x 3/4" in plastic box, \$1.00 postpaid.** Ramsbottom Printing, Box 2373, Kirksville, Missouri.

**CB QSL cards. Samples free.** Paul, 7701 Tisdale, Austin, Texas.

**QUALITY QSL's**—New designs monthly, samples 10¢, Giant 25¢. **SAVORY, 172 Roosevelt, Weymouth, Mass.**

CB QSL CARDS—100 two color \$3.00 postpaid, samples 10¢. Rusprint, Box 7507, Kansas City 16, Missouri.

\$10 DOWN DELIVERS your CB equipment with 12 to 24 months to pay balance. This month's specials . . . RG8/U coaxial cable only 7¢ per foot (FOB New York) . . . also, any CB transmit or receive crystal, for any type of CB transceiver . . . \$2 each. Include 25¢ additional with order for postage and handling of crystal. House of Sound, 2119 Starling Avenue, New York 62, N. Y.

Free Samples CB QSL Cards \$2.50 per 100 in 3 colors. Garth, Jurland, New Jersey.

QSL's 3-color glossy. 100 \$4.50. Rutgers Vari-typing Service. Free Samples. Thomas Street, Riegel Ridge, Milford, N. J.

QSL CARDS. Many sharp, cartoon designs . . . send for FREE brochure. F. B. Mathews Printing & Advertising, 1616 Rural Street, Rockford, Illinois.

MODULATION BOOSTER—It's new! It's terrific! As much as doubles your transmit and receive range with no violation of FCC power requirements. Compact, easy to install, with instructions. Net \$14.95. Dealers write too. ROKO Products, Inc., Box 3766, Baltimore 17, Maryland.

ANTENNA SWITCH—Operate one CB on two Antennas or two CB on one antenna. Attractive stainless steel, Takes PL-259 plugs. Net \$7.95. ROKO Products, Inc., Box 3766, Baltimore 17, Maryland.

CB QSLs. Glossy, two colors \$2.00 per 100, postpaid. Free sample. Hobby Print Shop, Umatilla, Fla.

NEW 1964 CB CALL AREA MAPS in dazzling red-on-white, big 8½" by 11" size, see next year's call prefixes NOW! Only 25¢ from "Wall Certificate," % S9 Magazine, 300 West 43rd St., New York 36, N. Y.

CB REPAIRS—CALIBRATION, reasonable prices, FCC licensed technicians. ELECTRONIC SPECIALTIES, Box 13, East Patchogue, N. Y. Atlantic 6-9467.

CREATIVE CBL CARDS—Free, new catalog and samples. Personal attention given. Wilkins Creative Printing, P.O. Box 1064-9, Atascadero, California.

CB-QSL's over 100 designs, samples 10¢. Roger KOAAB, 961 Arcade, St. Paul 6, Minn.

LOOKING? SHOPPING? TRADING? Trying to save money? Write Bob Graham for special deals on new and reconditioned used gear. Cash or Budget. Graham Radio, Dept. E, Reading Massachusetts, Tel: 944-4000.

WALKIE-TALKIES, Telecon Line, Direct from Japan 100 mw and 1 Watt Units. Catalog and Order Form Airmailed. Write Rotoken Corporation, 18 Mikawadai-Cho, Minato-ku, Tokyo.

NEW "AUDIO-AID-ALL" Clipper-Filter kit, fits any transceiver, boosts modulation, aids reception, \$10.99. Hy-Gain Mark II colinear, \$29.95. Omnitopper, \$10.97. Best buy! DB-2 BC/CB antenna coupler, \$4.99. Noisejector, NJ-7, \$4.49. Postpaid! For Heathkits, our preamps double reception! Sk-3 Preselector kit fits GW-10, GW-11, \$8.99. Sk-4 Preselector kit fits inside GW-12, \$8.99. Wired, \$11.99. Postpaid! HOLSTROM ASSOCIATES, Box 8640-S, Sacramento 22, California.

QSL'S, SWL'S, CB. SAMPLES 10¢. Nicholas & Son Printery, P.O. Box 11184, Phoenix 17, Arizona.

YOUR NAME & CALL on raised letters, self-sticking, plastic tape. Horizontal or vertical 25¢ per set. Minimum \$1.00. ALLEN, 430 Tillman, Lake Wales, Fla.

NOW—cards of distinction for discriminating CBers. Your photo on cards from snapshots or send us your ideas and designs for custom work by professional artist, samples 25¢. Dick McGee, 1444 Home Street, Jacksonville 7, Fla.

TONE SIGNALS. Legal. New "High-Level" pulse. Adaptable all units. \$4.95 each, complete. Ideal Enterprises, Box E, Wessington, S. D.

IMPROVE GW-10 PERFORMANCE! — Better transmission, reception! Reduce mobile noise! Instructions \$1.00, postpaid. FRANKEL, Box A-143. Wantagh, New York.

CB QSL card. Samples 10¢—MALGO PRESS, Box 375—Toledo 1, Ohio.

CB, QSL, SWL Cards that are different. Quality Card Stock. Samples 10¢ Home Print, 2416 Elmo, Hamilton, Ohio.

GLOSSY 3-color QSL cards 100 — \$4.50. Free samples. Rutgers Vari-Typing Service, 7 Fairfield Road, Somerset, New Jersey.

CB-HAM-QSL-EYEBALL Cards. Samples & Price List 20¢. Dave—KHG9638, Box 291, Waynesville, Ohio.

TWO POLY-COMM "N", new, factory sealed cartons. \$165 each, both for \$325 cash FOB Box 1294, Sarasota, Florida.

CB QSL Cards. New, Kute, Clever, Komical designs. Reasonable Prices. Brilliant colors including beautiful silver and gold. Samples FREE. M. Hellwig, Box 425, Lake Wales, Fla.

CB TRANSMITTERS \$6.00. Other bargains, send 10¢ for list. Vanguard, 190-48 99th Ave., Hollis 23, N. Y.

LOTS A BARGAINS on all kinds gear, new and used, CB, Hi-Fi, Ham, etc. Free list. Jim W8GGK, Rt. 1, Box 724, Stevensville, Mich.

CLUB COURTESY CARDS, 1000 for only \$4.50 postpaid. Send copy to Reed Advertising, 546 Pond Run Road, Raceland, Ky.

CB QSL CARD samples 25¢. Sackers, W8DED S9 Samples, Box 218, Holland, Michigan.



# LAFAYETTE CB SUPER VALUES



HE-100L

**39<sup>95</sup>**  
**2 For 78.88**  
No Money Down



- Uses Inexpensive Penlight Batteries
- No License, Tests or Age Limits
- Pocket Size—Only 9Hx3Wx2 $\frac{3}{4}$ "D

Complete Portable  
Communication For Everyone

**NEW!**  
**LAFAYETTE**  
**12** — TRANSISTOR  
**CITIZENS**  
**BAND**

**"WALKIE TALKIE"**  
with SQUELCH

- Separate Microphone and Speaker
- Fully Transistorized —12 Transistors
- Completely Wired

Complete with  
Leather Case,  
Earphone,  
Antenna, Batter-  
ies, and Crystal

**NEW!**  
**LAFAYETTE HE-75L**

**13**  
**TRANSISTOR**  
**1-WATT CB**

**"WALKIE TALKIE"**

**6650** No Money  
Down  
**2 For 129.00**

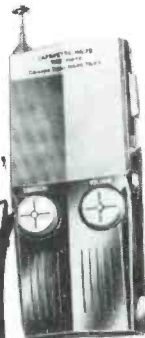

- 13 Transistors, 3 Diodes, 1 Thermistor
- Crystal Controlled Receive and Transmit
- Automatic Noise Limiter; Squelch; AVC
- Push-Pull Audio Output
- Superlative "Talk-Power"
- Runs on Penlight Cells or Optional Nickel Cadmium Rechargeable Battery Pack
- Meets FCC Requirements for Licensed Operation Part 19

**LAFAYETTE HE-20C CITIZENS BAND TRANSCEIVER**

Officially Approved  
for Use in  
CANADA  
Type Approval  
No. 169361029

**109.50**

- 8 Crystal Controlled Transmit Positions plus 8 Crystal Controlled Receive Positions
- Tuneable over all 23 Channels
- Built-in Power Supply for 110V AC or 12V DC
- Complete with Matched Crystals for Channel 9



SYOSSET, L. I., N. Y.  
JAMAICA, N. Y.  
NEW YORK N. Y.  
BRONX, N. Y.  
SCARSDALE, N. Y.

NEWARK, N. J.  
PLAINFIELD, N. J.  
PARAMUS, N. J.  
BOSTON, MASS.  
NATICK, MASS.

**LAFAYETTE RADIO ELECTRONICS**

LAFAYETTE RADIO ELECTRONICS DEPT. S9H3  
P.O. Box 10, Syosset, L. I., N. Y.

Send me the  
Free 1963 388-  
Page Lafayette  
Catalog

\$ \_\_\_\_\_ enclosed for Stock No. \_\_\_\_\_,  
shipping charges collect.

Name \_\_\_\_\_

Address \_\_\_\_\_

City \_\_\_\_\_

Zone \_\_\_\_\_

State \_\_\_\_\_

MAIL THE  
COUPON FOR  
YOUR FREE  
1963 LAFAYETTE  
CATALOG





# **COURIER 1-M**

---

**NOW!**

# **QUIETEST**

---

# **MOST POWERFUL**

# **MOBILE**

# **C.B. UNIT!**

# **HEAR IT TO BELIEVE IT!**

*Write for Free Brochure . . . . . \$229.50 list, slightly higher west of Rockies.*



**electronics communications, inc.** 325 no. macquesten pkwy, mt. vernon, n. y.

# General MC5 Sidebander

the measure of quality for all citizens band transceivers



## The World's most advanced 11 Meter two-way radio

**FREE—**  
Write for schematic  
and complete  
technical manual

3.25 watts minimum output. • Sideband receiver adapter\* for single and double sideband reception. • New Zener Diode shunt noise-clamp and series gated limiter circuit for highest noise limiting ever achieved. • New ultra-low drift oscillators for unsurpassed stability. • New Hi-Level Tone-Signal. • Illuminated "S" Meter. • 6V, 12V, 115V operation. • 15 watt construction. • Net Price including microphone and crystal... \$199.95. • \*Sideband receiver adapter optional \$19.95 + inst. Optional accessories available. 6 Volt or 12 Volt cord, each \$4.95. Crystal T or R, each \$2.95. 90 day warranty. F.O.B. Burbank, California.

Under present rules part 19.32 the FCC does not provide for more than (5) watt input in the Citizens Radio Service (26.965-27.225 MC Band)



## General's SIDEBAND TRANSMITTER —Available February 15, 1963!

A new concept in C.B. Communications. A Sideband Transmission Adapter and AM Linear Amplifier all in one package...and best of all True Electronic Switching—Just plug it into the antenna. This unit may also be used on the 10 meter band at 50 Watts P.E.P. Sideband and 25 Watts P.E.P. AM with only 3 watts of drive.

This Dual Function...Sideband and AM Linear Amplifier for 10 and 11 meters is only \$99.95 Net. F.O.B. Burbank, California.

# GENERAL RADIOTELEPHONE COMPANY

3501 West Burbank Boulevard, Burbank, California



300 West 43rd Street  
New York 36, N.Y.

Controlled Circulation Postage Paid at New York, N. Y.